

RobotLinking

THE 37 SENSOR KIT TUTORIAL

Preface

About RobotLinking

RobotLinking is a technology company focused on 3D Printer, Raspberry Pi and Arduino open source community development. Committed to the promotion of open source culture, we strive to bring the fun of electronics making to people all around the world and enable everyone to be a maker. Our products include learning kits, development boards, robots, sensor modules, development tools and printer machine. In addition to high quality products, RobotLinking also offers video tutorials to help your own project. If you have interest in open source or making something cool, welcome to join us! Visit www.RobotLinking.com for more!

About 37 Sensor Kit

This 37 Sensor Kit is suitable for RobotLinking Uno, RobotLinking Mega 2560, RobotLinking Duemilanove and RobotLinking Nano. All the code in this user guide is also compatible with these boards.

Our RobotLinking board is fully compatible with Arduino.

This kit walks you through the basics of using the RobotLinking board in a hands-on way. You'll learn through building several creative projects. The kit includes a selection of the most common and useful electronic components. Starting from the basics of electronics, to more complex projects, the kit will help you control the physical world with components.





In this book, we will show you circuits with both realistic illustrations and schematic diagrams. You can go to our official website www.RobotLinking.com to download related code.



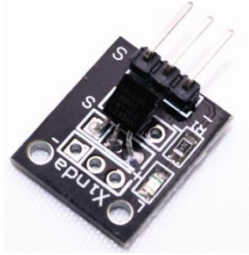

If you have any questions, please send an email to support@RobotLinking.com. You can also leave a message and share your projects on our forum.

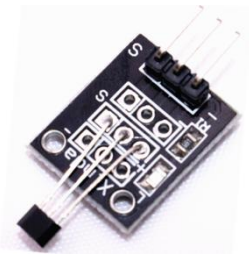
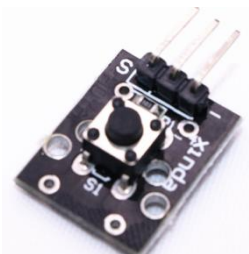

Contents



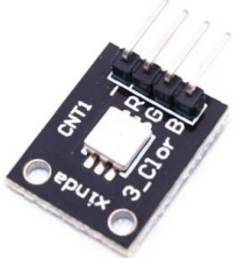

LESSON 1 TEMP AND HUMIDITY MODULE	11
LESSON 2 SHOCK SWITCH	14
LESSON 3 HALL MAGNETIC SENSOR MODULE	16
LESSON 4 BUTTON SWITCH	18
LESSON 5 INFRARED RECEIVER AND IR EMISSION.....	20
LESSON 6 PASSIVE BUZZER MODULE	25
LESSON 7 LASER MODULE.....	27
LESSON 8 SMD RGB MODULE AND RGB MODULE.....	29
LESSON 9 DS18B20 DIGITAL TEMPERATURE SENSOR MODULE	32
LESSON 10 PHOTO-INTERRUPTER MODULE	34
LESSON 11 MERCURY SWITCH	36
LESSON 12 TILT SWITCH MODULE.....	38
LESSON 13 REED SWITCH AND MINI REED SWITCH MODULE.....	40
LESSON 14 DUAL-COLOR COMMON-CATHODE LED	43
LESSON 15 KNOCK SENSOR.....	45
LESSON 16 DIGITAL TEMPERATURE MODULE	47
LESSON 17 FLAME SENSOR MODULE	49
LESSON 18 MENTAL TOUCH MODULE.....	51
LESSON 19 ANALOG TEMP MODULE.....	53
LESSON 20 PHOTORESISTOR MODULE	56
LESSON 21 7 COLOR FLASH LED MODULE	59
LESSON 22 HIGH-SENSITIVE VOICE SENSOR	61
LESSON 23 MAGIC LIGHT CUP MODULE.....	64
LESSON 24 JOYSTICK MODULE.....	66
LESSON 25 LINEAR HALL AND ANALOG HALL MODULE.....	69
LESSON 26 TRACKING MODULE AND AVOIDANCE MODULE	72
LESSON 27 ROTARY ENCODERS MODULE	75
LESSON 28 1 CHANNEL RELAY MODULE.....	78
LESSON 29 HEARTBEAT MODULE.....	80

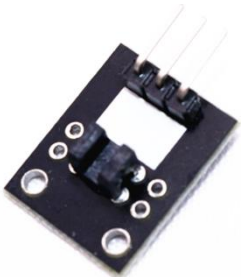
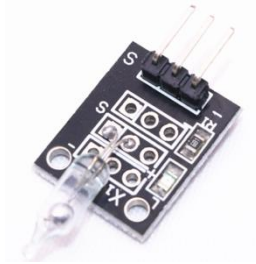
Components List

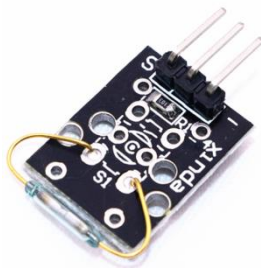
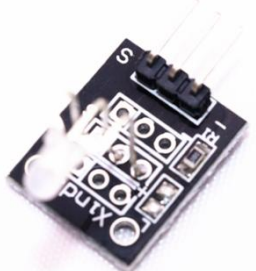

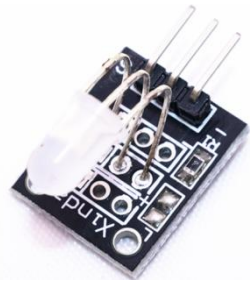
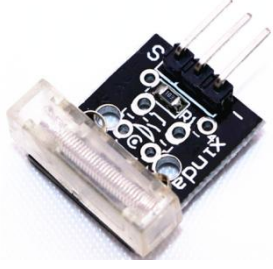

No	Product Name	Quantity	Picture
1	DS18B20 Module	1	
2	SHOCK SWITCH	1	
3	Hall Magnetic sensor Module	1	
4	BUTTON SWITCH	1	
5	Infrared Receiver	1	

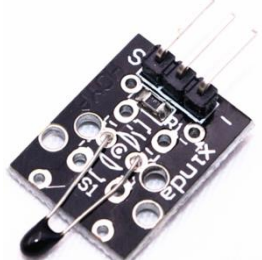
6	IR Emission	1	
7	Passive buzzer	1	
8	Laser module	1	
9	SMD RGB module	1	
10	RGB LED module	1	
11	TEMP and humidity module	1	

12	Photo-interrupter MODULE	1	
13	Mercury Switch	1	
14	Tilt SWITCH MODULE	1	
15	Reed switch module	1	
16	Mini reed switch module	1	
17	Mini two-color module	1	

18	Dual-color Common-Cathode LED	1	
19	Knock Sensor	1	
20	Digital temperature module	1	
21	Flame module	1	
22	MENTAL TOUCH MODULE	1	
23	Analog temp module	1	

24	Photo-resistor module	1	
25	7 color flash module	1	
26	High-sensitive Voice Sensor	1	
27	Magic light cup MODULE	2	
28	Joystick module	1	
29	Linear hall module	1	

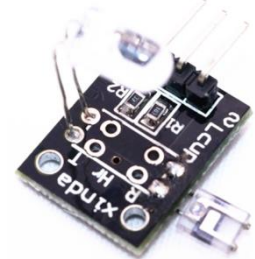
30	Analog hall module	1	 <p>Analog hall module with a black PCB, a potentiometer, and three pins.</p>
31	Avoidance module	1	 <p>Avoidance module with a black PCB, two potentiometers, and three pins.</p>
32	Tracking module	1	 <p>Tracking module with a black PCB, a potentiometer, and three pins.</p>
33	Rotary encoders module	1	 <p>Rotary encoders module with a black PCB, a rotary encoder, and three pins.</p>
34	Buzzer module	1	 <p>Buzzer module with a black PCB, a buzzer, and three pins.</p>
35	Heartbeat module	1	 <p>Heartbeat module with a black PCB, a heart rate sensor, and three pins.</p>

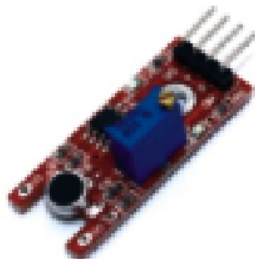
36	Relay module	1	
37	Small sound module	1	

Note:

After unpacking, please check that the number of components is correct and that all components are in good condition.

Lesson 1 TEMP AND HUMIDITY MODULE

Introduction

In this tutorial we will learn how to use a DHT11 Temperature and Humidity Sensor.

It's accurate enough for most projects that need to keep track of humidity and temperature readings.

Again we will be using a Library specifically designed for these sensors that will make our code short and easy to write.

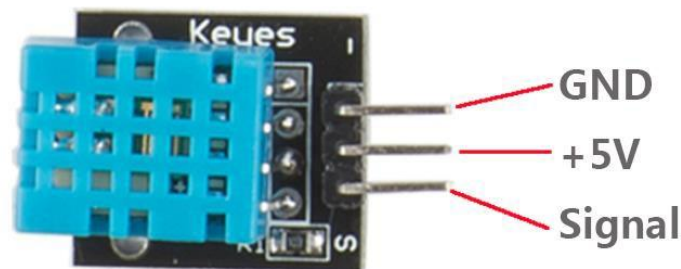

Components

- 1 * RobotLinking Uno board
- 1 * USB cable
- 1 * temp and humidity module
- DuPont wires(Female to Male)

Principle

Experimental Procedures

Step 1: Connect circuit as shown in the following photo:

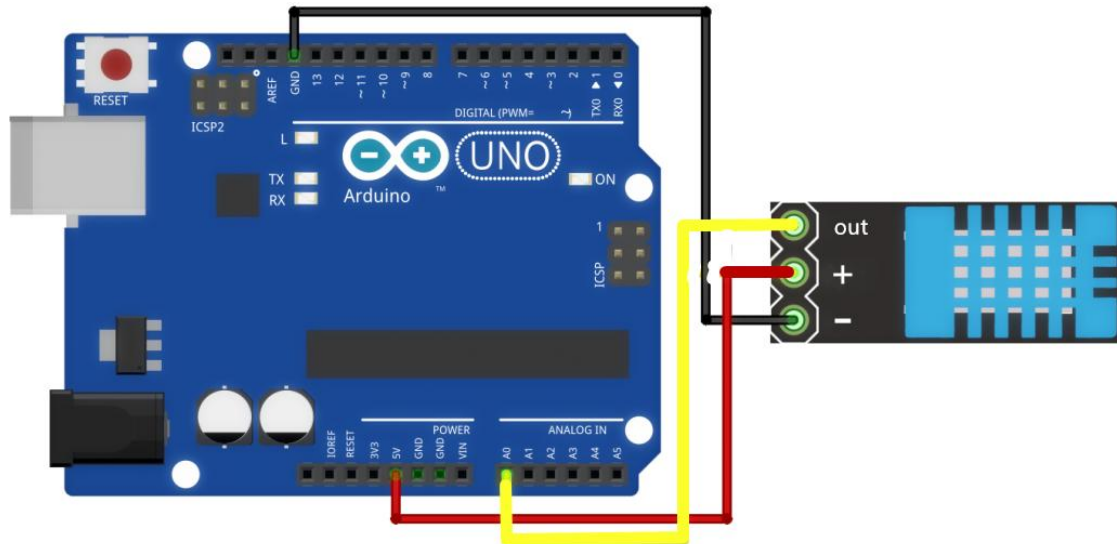

As you can see we only need 3 connections to the sensor, since one of the pin is not used. The connection are : Voltage, Ground and Signal which can be connected to any Analog Pin on our UNO.

Step 2: Once you have the library, just go ahead and extract it to the Library folder inside your Arduino IDE software folder.

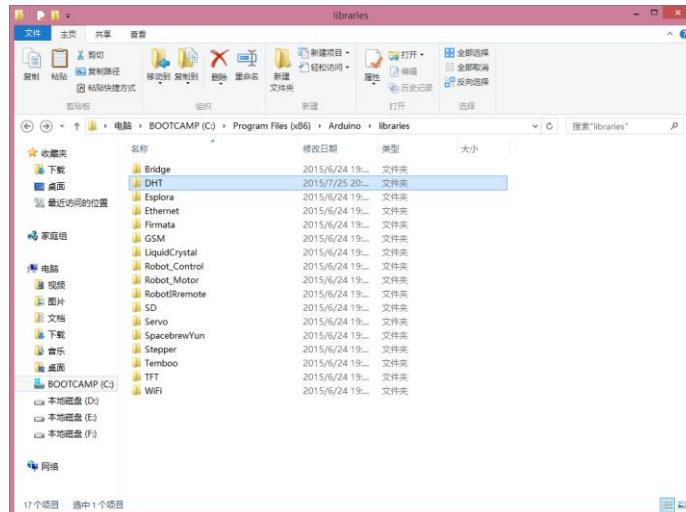

Step 3: Program (please refer to the example code on the CD or official website)

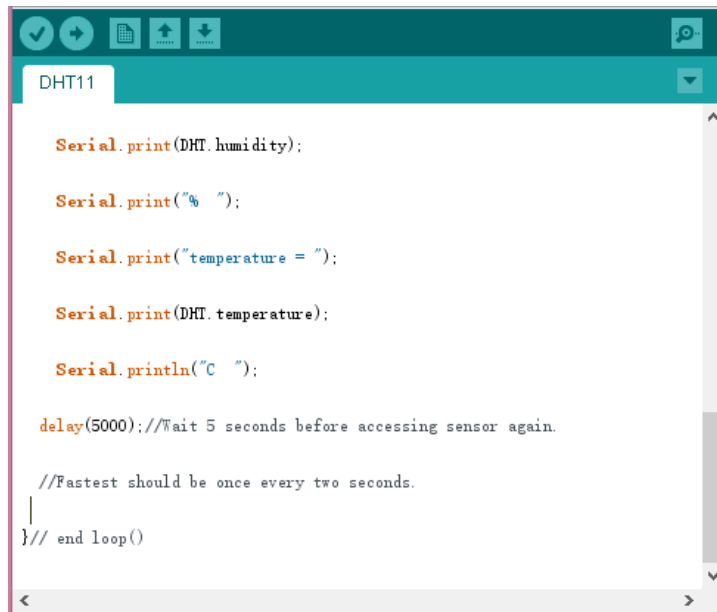

```
DHT11

Serial.print(DHT.humidity);

Serial.print(" ");

Serial.print("temperature = ");

Serial.print(DHT.temperature);

Serial.println("C ");

delay(5000); //Wait 5 seconds before accessing sensor again.

//Fastest should be once every two seconds.
|
} // end loop()
```

Step 3: Compile the program

Step 4: Burn the program into RobotLinking Uno board

Step 5: Open the tool → Serial Monitor, then you can see the humidity and temperature.

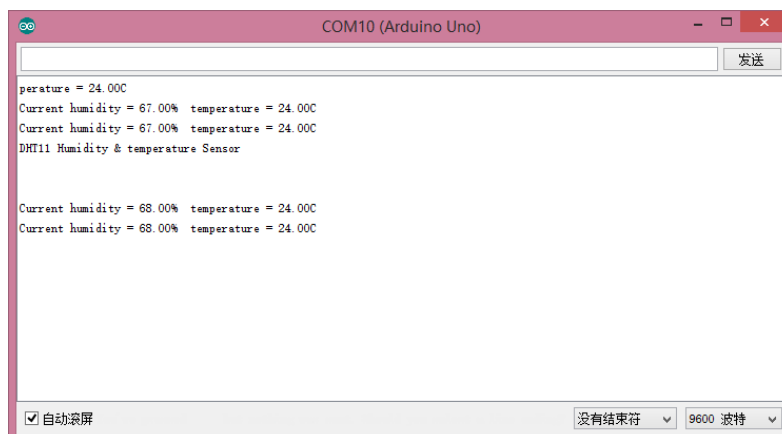

```
COM10 (Arduino Uno) 发送

perature = 24.00C
Current humidity = 67.00% temperature = 24.00C
Current humidity = 67.00% temperature = 24.00C
DHT11 Humidity & temperature Sensor

Current humidity = 68.00% temperature = 24.00C
Current humidity = 68.00% temperature = 24.00C

 自动滚屏 没有结束符 9600 波特
```

Experimental Summary

Temp and humidity module are a very simple, very practical technology that is surprisingly easy to master. If you feel as though you're struggling, check out our video tutorials on www.RobotLinking.com or ask us questions on our forum.

Lesson 2 SHOCK SWITCH

Introduction

In this experiment, we will learn how to use SHOCK SWITCH.

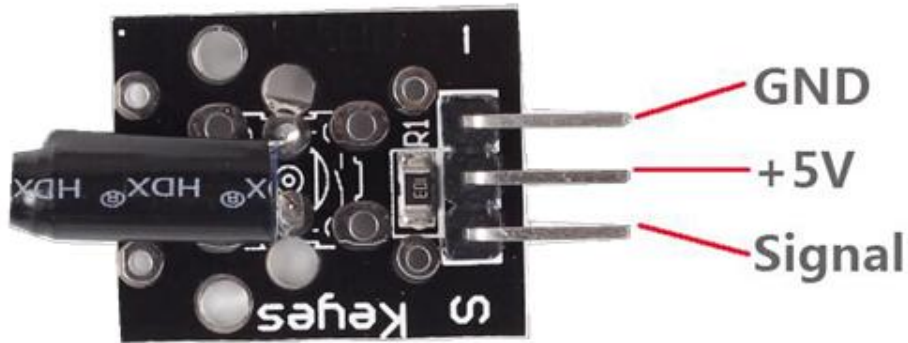

Components

- 1 * RobotLinking Uno board
- 1 * USB cable
- 1 * Shock Switch module
- DuPont wires(Female to Male)

Principle

SHOCK SWITCH and number 13 port have the built-in LED simple circuit. To produce a SHOCK SWITCH flasher, we can use connect the digital port 13 to the built-in LED and connect the SHOCK SWITCH S port to number 3 port of RobotLinking Uno board. When the SHOCK SWITCH sensing, LED twinkle light to the SHOCK SWITCH signal.

Experimental Procedures

Step 1: Connect circuit as shown in the following photo:

The power cord, ground wire and S port of SHOCK SWITCH connected to the Arduino board experiment of +5v, GND and 3 port.

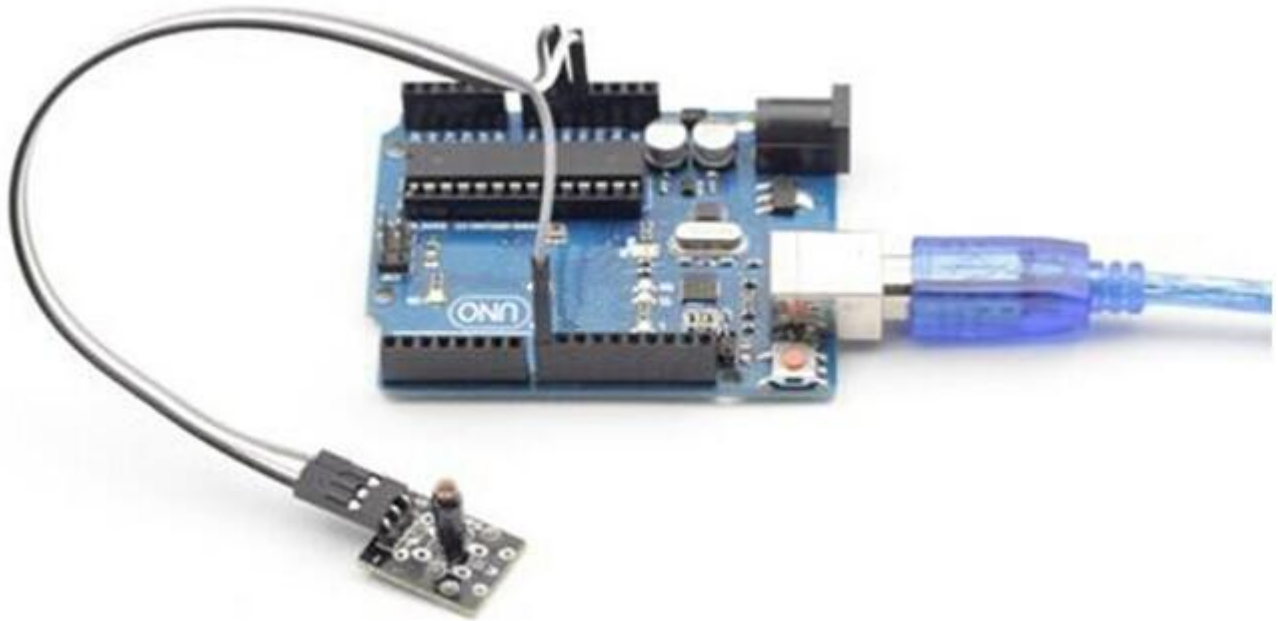

Step 2: Program (please refer to the example code on the CD or official website)

Step 3: Compile the program

Step 4: Burn the program into RobotLinking Uno board

Experimental Summary

SHOCK SWITCH is a very simple, very practical technology that is surprisingly easy to master. If you feel as though you're struggling, check out our video tutorials on www.RobotLinking.com or ask us questions on our forum.

Lesson 3 HALL MAGNETIC SENSOR MODULE

Introduction

In this experiment, we will learn how to use hall magnetic sensor module.

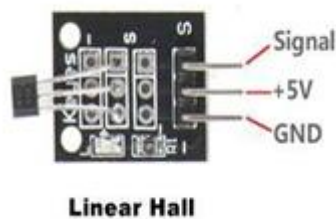

Components

- 1 * RobotLinking Uno board
- 1 * USB cable
- 1 * hall magnetic sensor module
- DuPont wires(Female to Male)

Principle

Hall magnetic module and number 13 port have the built-in LED simple circuit. To produce a magnetic flasher, we can use connect the digital port 13 to the built-in LED and connect the magnetic sensor S port to number 3 port of RobotLinking Uno board. When the hall magnetic sensor sensing, LED twinkle light to the hall magnetic sensor signal.

Experimental Procedures

Step 1: Connect circuit as shown in the following photo:

The power cord, ground wire and S port of hall magnetic sensor module connected to the Arduino board experiment of +5v, GND and 3 port.

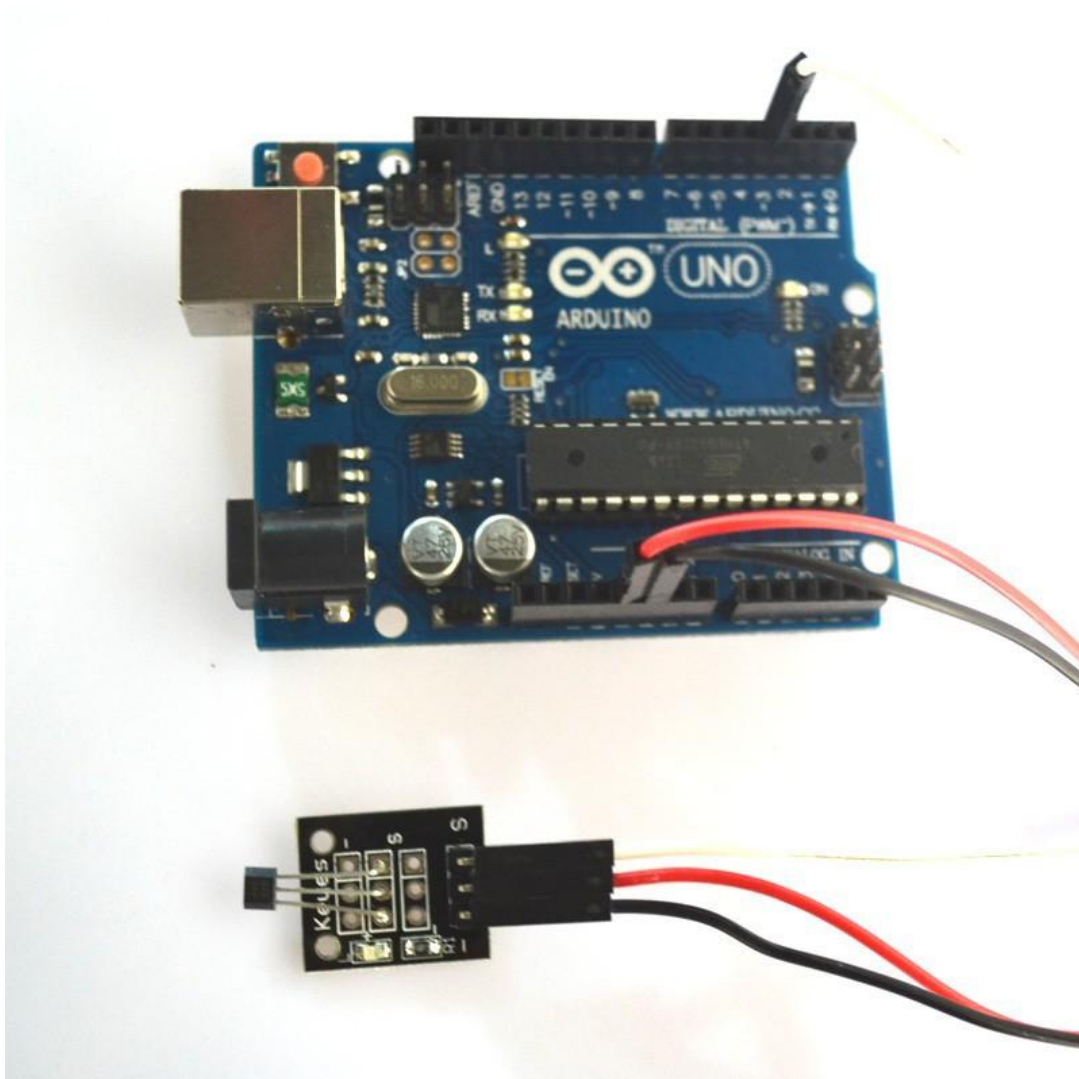

Step 2: Program (please refer to the example code on the CD or official website)

Step 3: Compile the program

Step 4: Burn the program into RobotLinking Uno board

Experimental Summary

Hall magnetic sensor module is a very simple, very practical technology that is surprisingly easy to master. If you feel as though you're struggling, check out our video tutorials on www.RobotLinking.com or ask us questions on our forum.

Lesson 4 BUTTON SWITCH

Introduction

In this experiment, we will learn how to use BUTTON SWITCH.

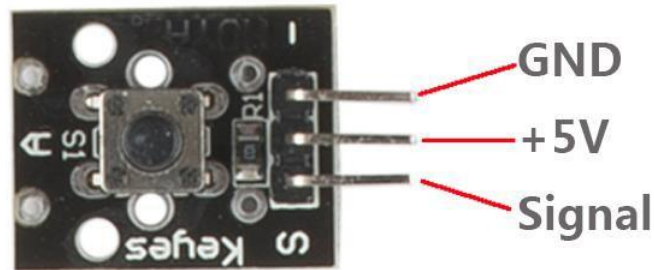

Components

- 1 * RobotLinking Uno board
- 1 * USB cable
- 1 * Button switch
- DuPont wires(Female to Male)

Principle

BUTTON SWITCH and number 13 port have the built-in LED simple circuit. To produce a switch flasher, we can use connect the digital port 13 to the built-in LED and connect the BUTTON SWITCH S port to number 3 port of RobotLinking Uno board. When the switch sensing, LED twinkle light to the switch signal.

Experimental Procedures

Step 1: Connect circuit as shown in the following photo:

The power cord, ground wire and S port of switch module connected to the Arduino board experiment of +5v, GND and 3 port.

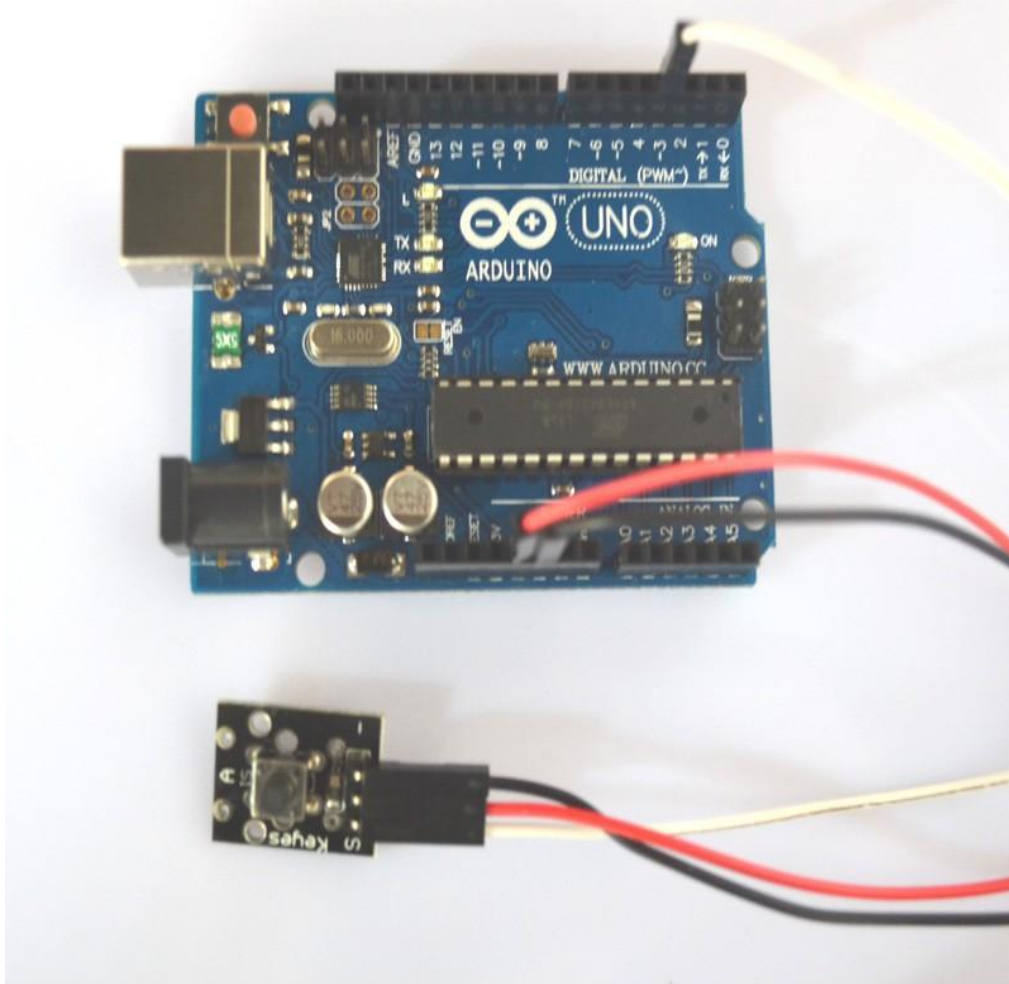

Step 2: Program (please refer to the example code on the CD or official website)

Step 3: Compile the program

Step 4: Burn the program into RobotLinking Uno board

Experimental Summary

BUTTON SWITCH is a very simple, very practical technology that is surprisingly easy to master. If you feel as though you're struggling, check out our video tutorials on www.RobotLinking.com or ask us questions on our forum.

Lesson 5 Infrared Receiver and IR Emission

Introduction

In this experiment, we will learn how to use Infrared Receiver and IR Emission module.

In fact now in our daily life they play an important role, a lot of household electrical appliances are used to this kind of device, such as air conditioning, TV, DVD, etc. Actually it is based on its wireless remote sensing and it is very convenient by using them.

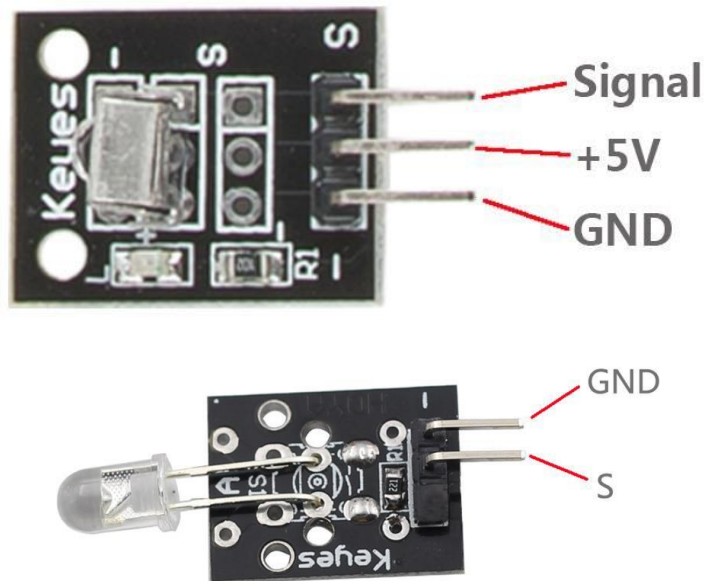

Components

- 2 * RobotLinking Uno board
- 2 * USB cable
- 1 * Infrared Receiver
- 1 * IR Emission module
- DuPont wires(Female to Male)

Principle

Firstly, let's know the structure of the infrared receiving head: there are two important elements inside the infrared receiving head, IC and PD. IC is receiving head processing components, mainly composed of silicon and circuit. It is a highly integrated device. The main function is filter, plastic, decoding, amplification, etc. PD is a photosensitive diode. The main function is to receive the light signal.

Below is a brief working principle diagram:

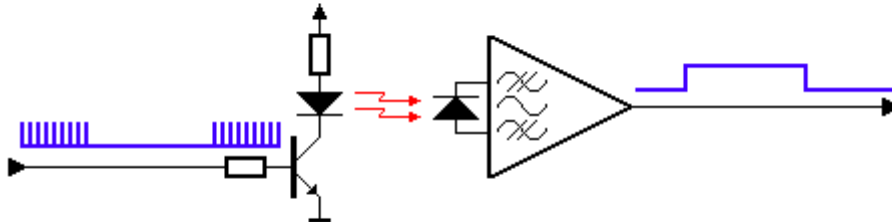

Infrared emitting diode launch out the modulation signal and infrared receiver head will receive, decode, filter and so on to regain the signal .

Infrared emitting diode: keep clean and in good condition. All the parameters in the process of working shall not exceed the limit value (positive To the current 30~60mA, positive pulse current 0.3~1A, reverse voltage 5V, dissipation power 90mW, working temperature range -25~+80°C, and storage temperature range between 40~100°C, the welding temperature 260 °C) infrared tube with a closed head should be matching use, otherwise it will influence the sensitivity.

Experimental Procedures

Step 1: We first look at diagram, understand the infrared emission and receiving module specific connection with Arduino:

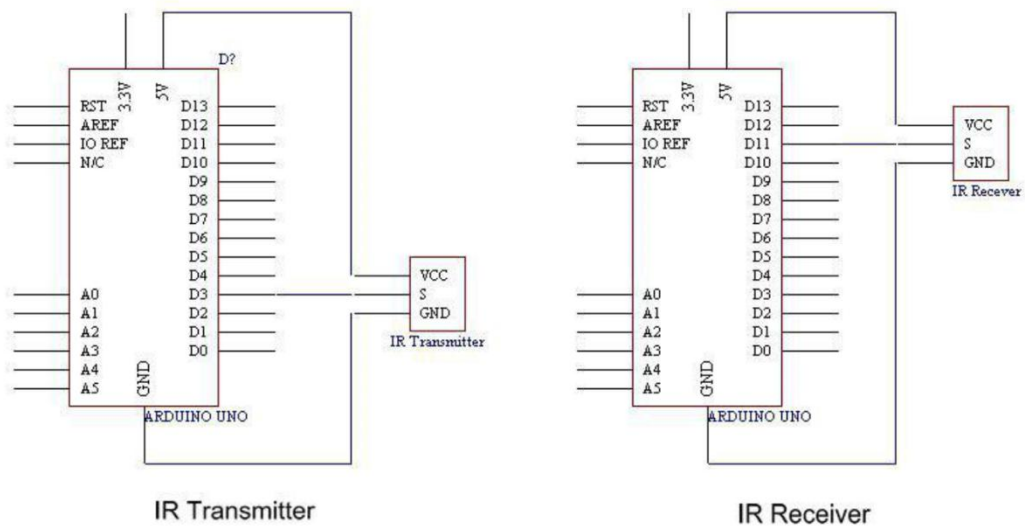

Step 2: Connect circuit as shown in the following photo:

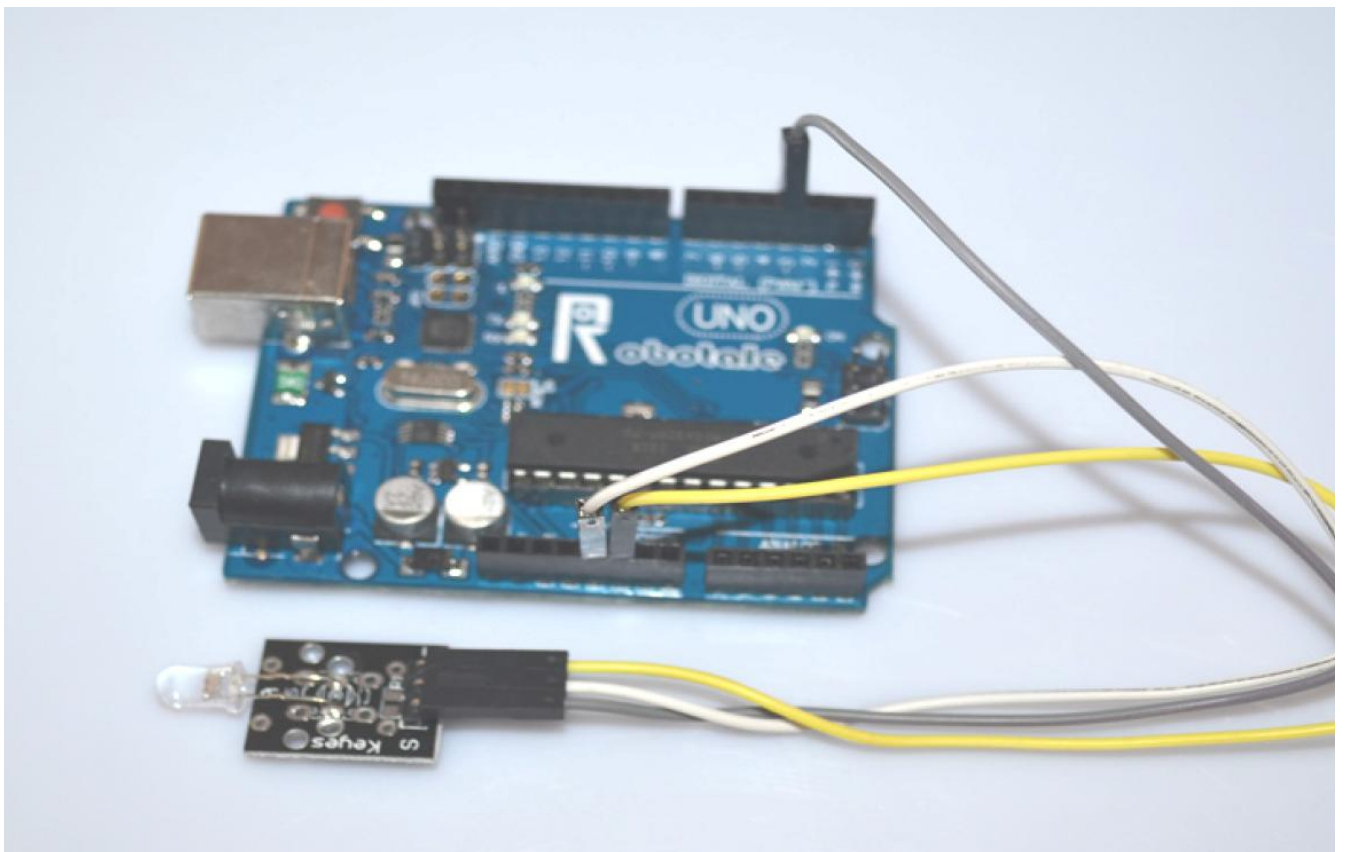

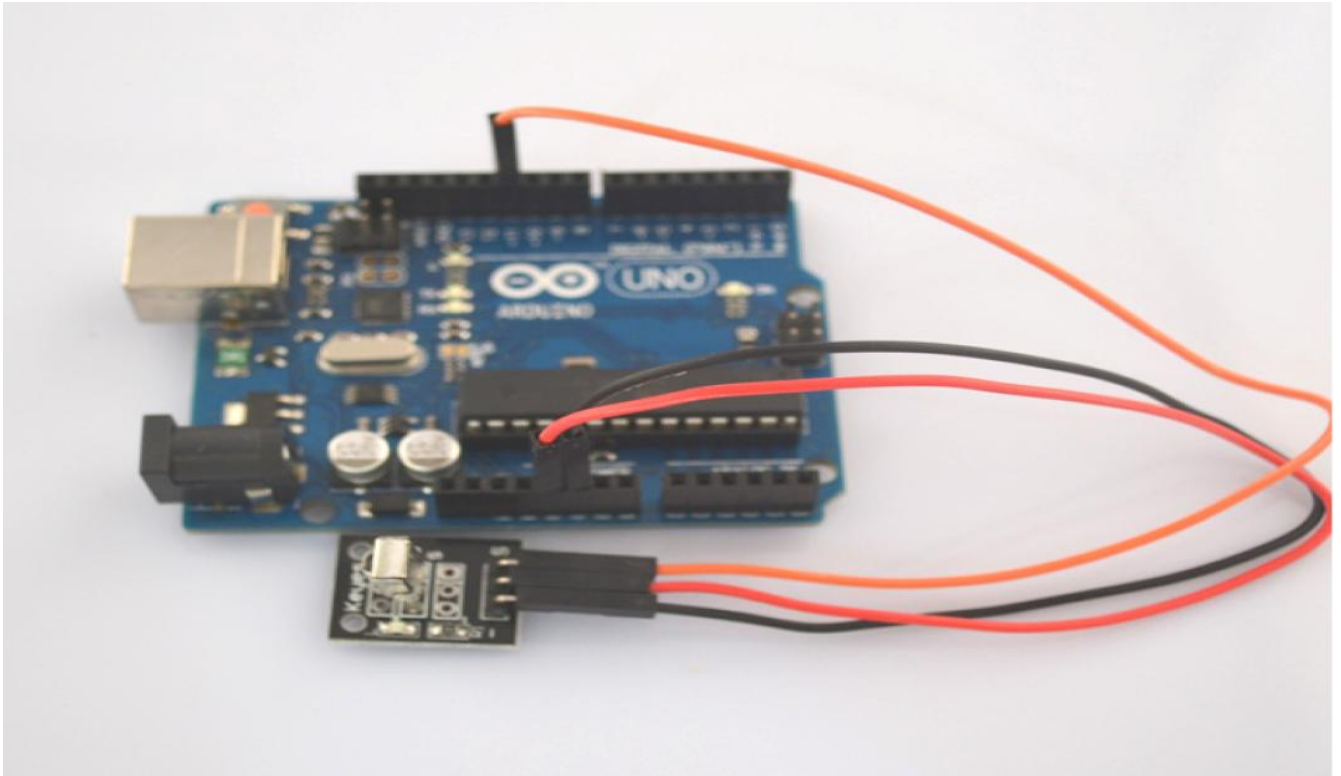

Step 3: Program (please refer to the example code on the CD or official website)

Step 4: Compile the program

Step 5: Burn the program into RobotLinking Uno board

Step 6: Open the TOOL→Serial Monitor, and we can see the data as below:

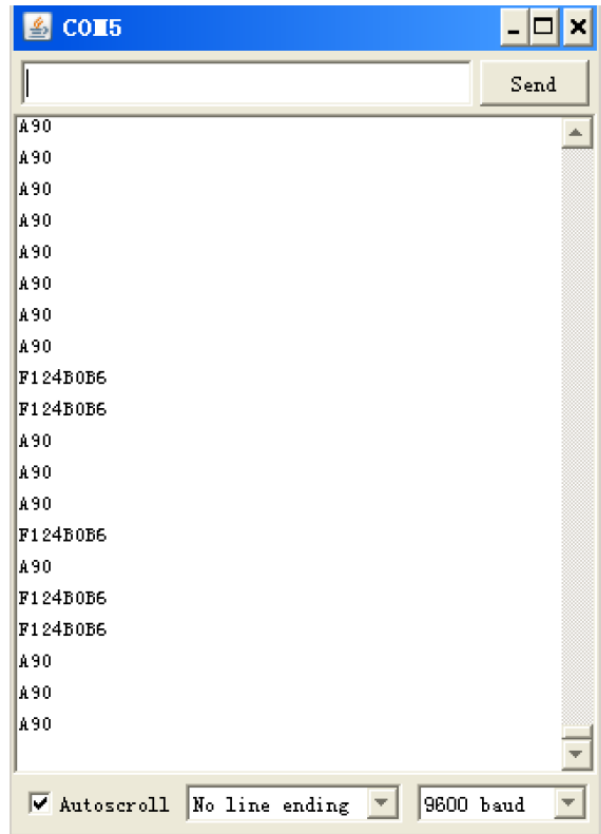
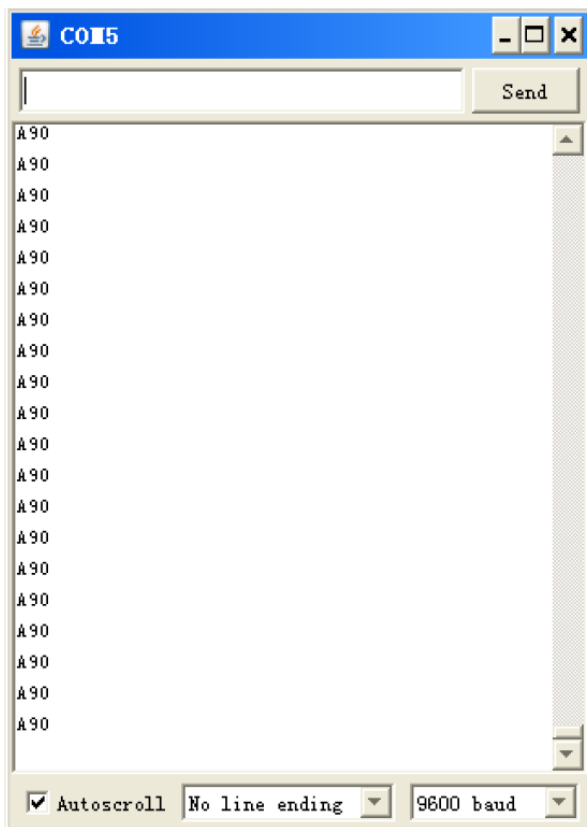

Experimental Summary

The reason that we feel infrared is a magical thing is because we can't see and touch the infrared. But it doesn't matter, the most important thing is we can control it and make it serve us, in fact, we are even more amazing. If you feel as though you're struggling, check out our video tutorials on www.RobotLinking.com or ask us questions on our forum.

Lesson 6 PASSIVE BUZZER MODULE

Introduction

In this experiment, we will learn how to use passive buzzer module.

With the Arduino we can complete a lot of interactive work, commonly what we used is the light shows. And we have been use the LED small lights in the experiment before. In this experiment we will make the circuit having noise. The common components that can make sound are buzzer and speakers. Compared to the speaker, buzzer is more simple and easy to use so in this experiment we adopts the buzzer.

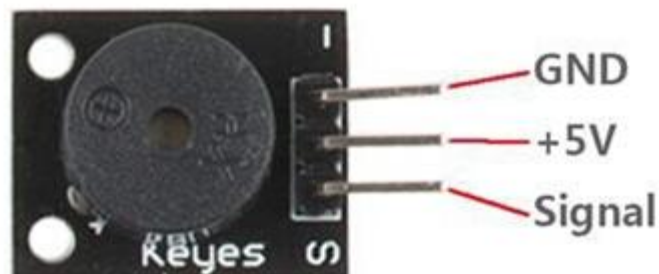

Passive

Components

- 1 * RobotLinking Uno board
- 1 * USB cable
- 1 * Passive buzzer module
- DuPont wires(Female to Male)

Principle

Function of buzzer: Voice device of the computer, printer, copier, alarm, electronic toys, automotive electronic equipment, telephone, timer and other electronic products

The classification of the buzzer: buzzer is mainly divided into piezoelectric buzzer and magnetic buzzer.

The circuit graphic symbol of buzzer: the letter "H" or "HA".

Experimental Procedures

Step 1: Connect circuit as shown in the following photo:

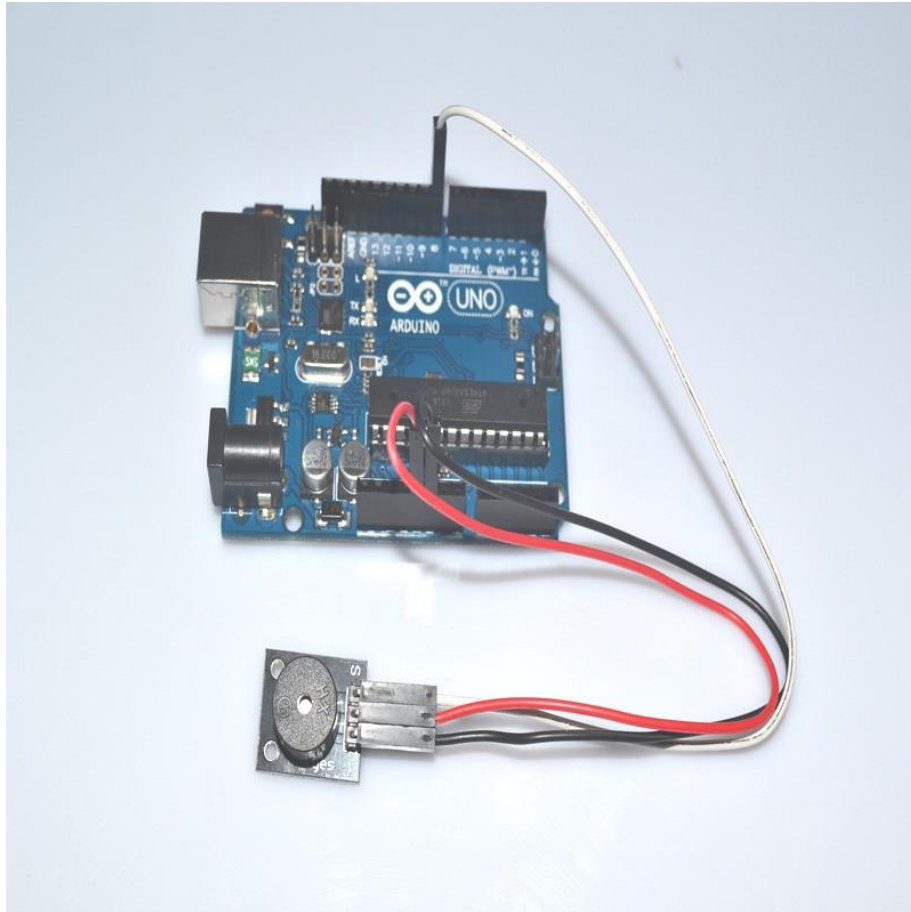

Step 2: Program (please refer to the example code on the CD or official website)

Step 3: Compile the program

Step 4: Burn the program into RobotLinking Uno board

Experimental Summary

Passive buzzer module are a very simple, very practical technology that is surprisingly easy to master. If you feel as though you're struggling, check out our video tutorials on www.RobotLinking.com or ask us questions on our forum.

Lesson 7 LASER MODULE

Introduction

In this experiment, we will learn how to use laser module.

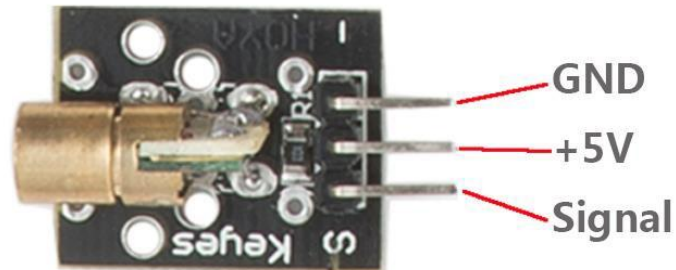

Components

- 1 * RobotLinking Uno board
- 1 * USB cable
- 1 * Laser module
- DuPont wires(Female to Male)

Principle

Experimental Procedures

Step 1: Connect circuit as shown in the following photo:

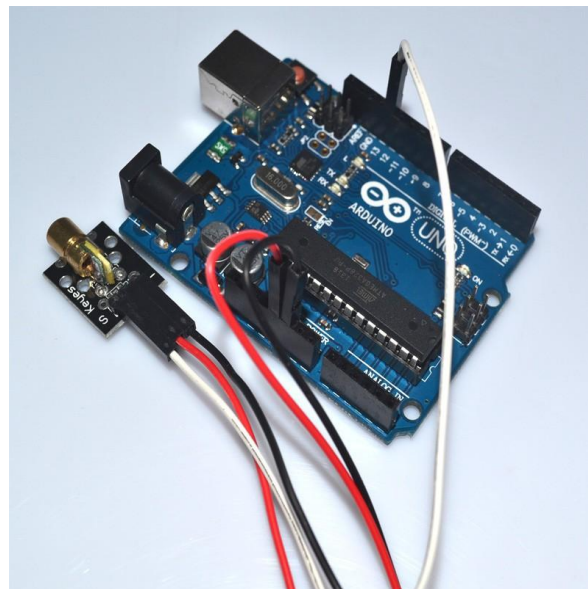

Step 2: Program (please refer to the example code on the CD or official website)

Step 3: Compile the program

Step 4: Burn the program into RobotLinking Uno board

Experimental Summary

Laser module are a very simple, very practical technology that is surprisingly easy to master. If you feel as though you're struggling, check out our video tutorials on www.RobotLinking.com or ask us questions on our forum.

Lesson 8 SMD RGB MODULE AND RGB MODULE

Introduction

In this experiment, we will learn how to use SMD RGB module and RGB module.

Actually, the function of SMD RGB module and RGB module are almost the same. But we can choose the shape we like or we need.

SMD RGB LED module and RGB module are made from a patch of full-color LED. By adjusting the voltage input of R, G, B pins, we can adjust the strength of the three primary colors (red/blue/green) so as to implement the result of full color melange effect.

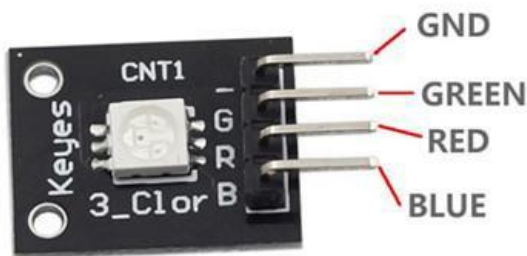

SMD Package

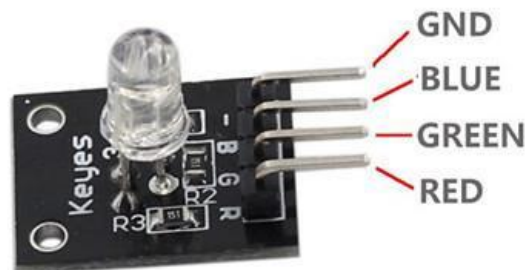

DIP Package

Components

- 1 * RobotLinking Uno board
- 1 * USB cable
- 1 * SMD RGB module
- 1 * RGB module
- DuPont wires(Female to Male)

Principle

RGB tricolor connect to current-limiting resistance to prevent burn out

PWM adjust the mixed of three primary colors so that we can have different colors

Working voltage: 5v

The LED drive mode: Common cathode

Experimental Procedures

Step 1: Connect circuit as shown in the following photo:

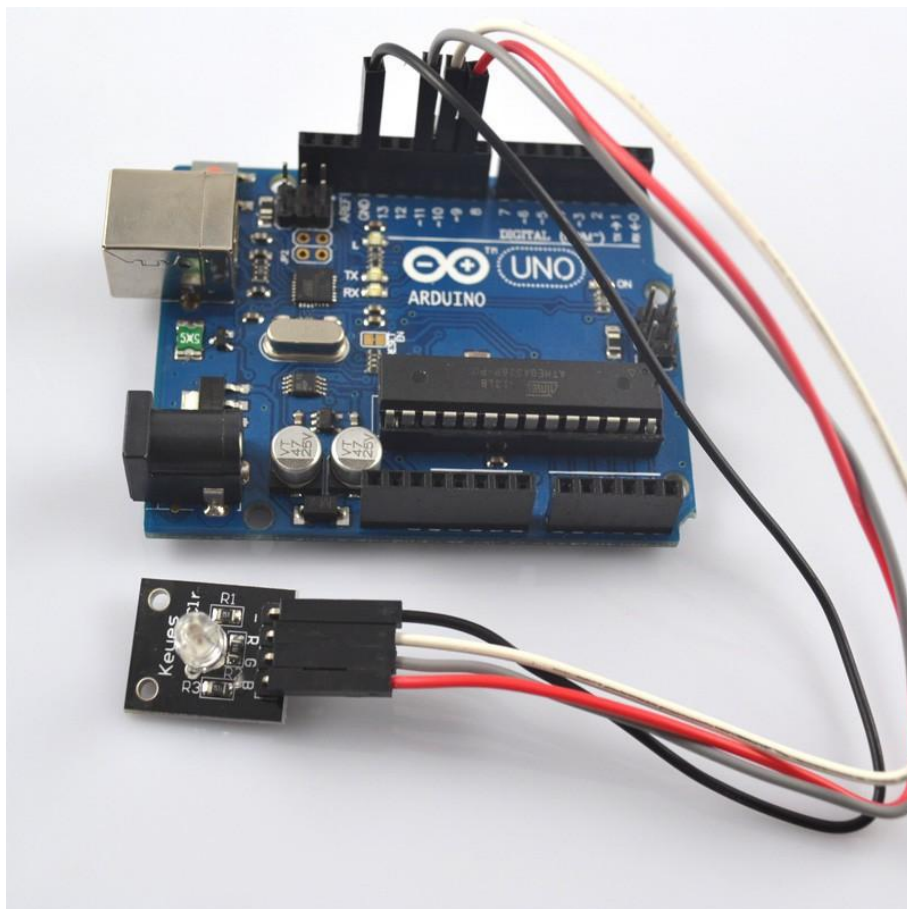
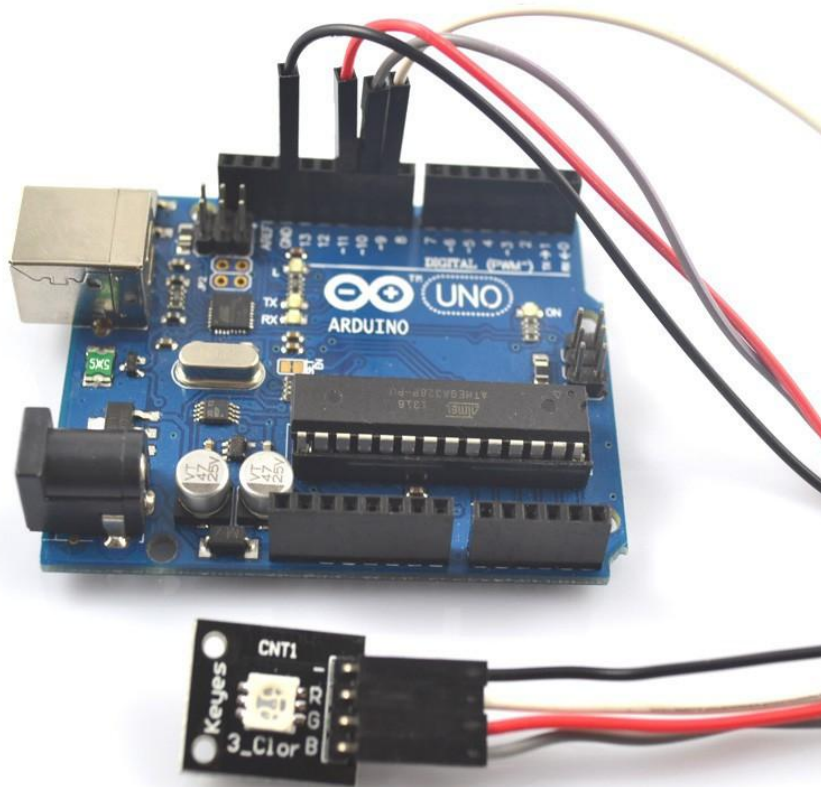

Step 2: Program (please refer to the example code on the CD or official website)

Step 3: Compile the program

Step 4: Burn the program into RobotLinking Uno board

Experimental Summary

These two module are a very simple, very practical technology that is surprisingly easy to master. If you feel as though you're struggling, check out our video tutorials on www.RobotLinking.com or ask us questions on our forum.

Lesson 9 DS18B20 DIGITAL TEMPERATURE SENSOR MODULE

Introduction

In this experiment, we will learn how to use DS18B20 module test the environmental temperature and make a thermometer.

Since the previous temperature sensor output is analog. So we need to add additional A/D and D/A chip into the line transformation. More -over, the Arduino external port is not rich resources and the utilization rate is not high. These cause a big challenge. So we are create the Ds18b20 module.

The new DS18B20 Temperature Sensor Module is very good solve the problem. It have the characteristic of the economy, unique 1-wire bus and it can fully apply the Arduino platform. Users can easily form a sensor network through using this module.

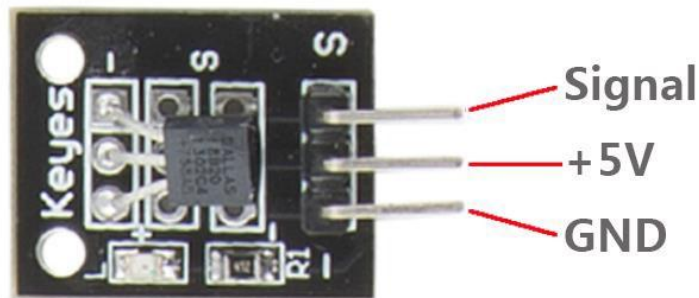

Components

- 1 * Robot Linking Uno board
- 1 * USB cable
- 1 * DS18B20 module
- DuPont wires(Female to Male)

Principle

DS18B20 module is using a single bus. The power supply voltage range of 3.0 V to 5.5 V and no standby power supply. It can Measure temperature range for -55 degree to +125 degree with accuracy of +/-0.5°C.

The programmable DPI of temperature sensor is From 9 to 12. temperature conversion is 12 digits lattice type. maximum is 750 milliseconds. Families can be defined non-volatile temperature alarm Settings.

Each DS18B20 contains a unique serial number so that multiple ds18b20s can exist in a bus.

Temperature sensor can detect temperature in numbers of different places at the same time.

Experimental Procedures

Step 1: Connect circuit as shown in the following photo:

The power cord, ground wire and S port of DS18B20 connected to the Arduino board experiment of +5v, GND and 12 port.

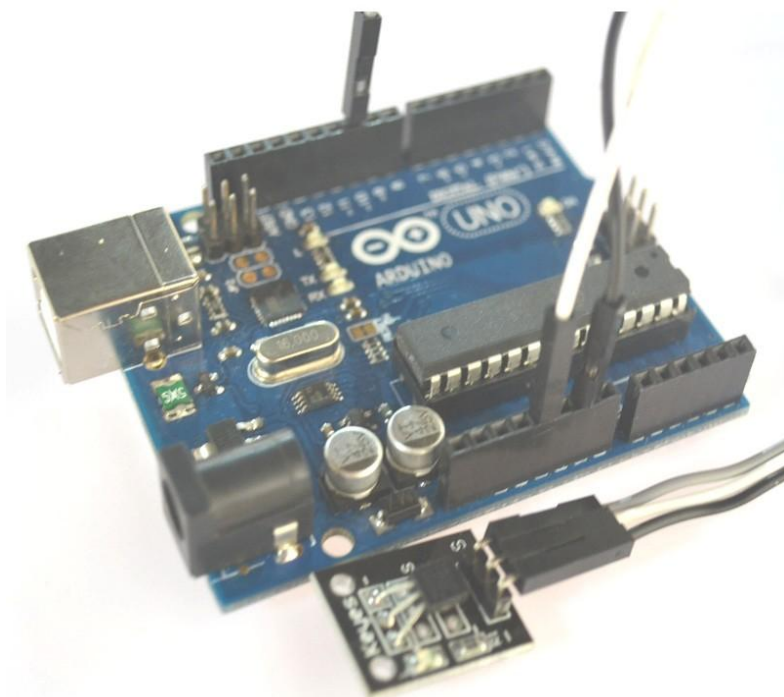

Step 2: Open PROJECT → Include Library → Manage Libraries → install the "One Wire" and "Dallas Temperature" libraries .

Step 3: Program (please refer to the example code on the CD or official website)

Step 4: Compile the program

Step 5: Burn the program into RobotLinking Uno board

Step 6: Open the TOOL→Serial Monitor, and we can see the temperature. When doing the experiment, the temperature is 27 degrees Celsius. With the hand touch the DS18B20, through the serial port we can be found there is an obvious change in temperature

Experimental Summary

DS18B20 module are a very simple, very practical technology that is surprisingly easy to master. If you feel as though you're struggling, check out our video tutorials on www.RobotLinking.com or ask us questions on our forum.

Lesson 10 Photo-interrupter MODULE

Introduction

In this experiment, we will learn how to use Photo-interrupter MODULE.

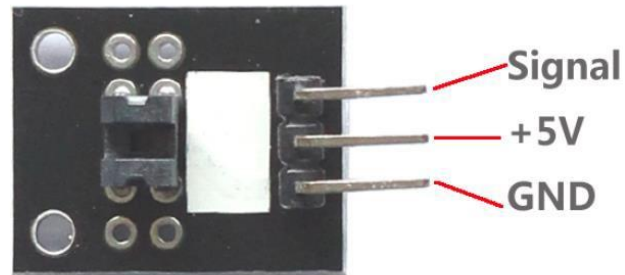

Components

- 1 * RobotLinking Uno board
- 1 * USB cable
- 1 * Photo-interrupter MODULE
- DuPont wires(Female to Male)

Principle

Photo-interrupter module and number 13 port have the built-in LED simple circuit. To produce a switch flasher, we can use connect the digital port 13 to the built-in LED and connect the Photo-interrupter MODULE S port to number 3 port of RobotLinking Uno board. When the switch sensing, LED twinkle light to the switch signal.

Experimental Procedures

Step 1: Connect circuit as shown in the following photo:

The power cord, ground wire and S port of switch module connected to the Arduino board experiment of +5v, GND and 3 port.

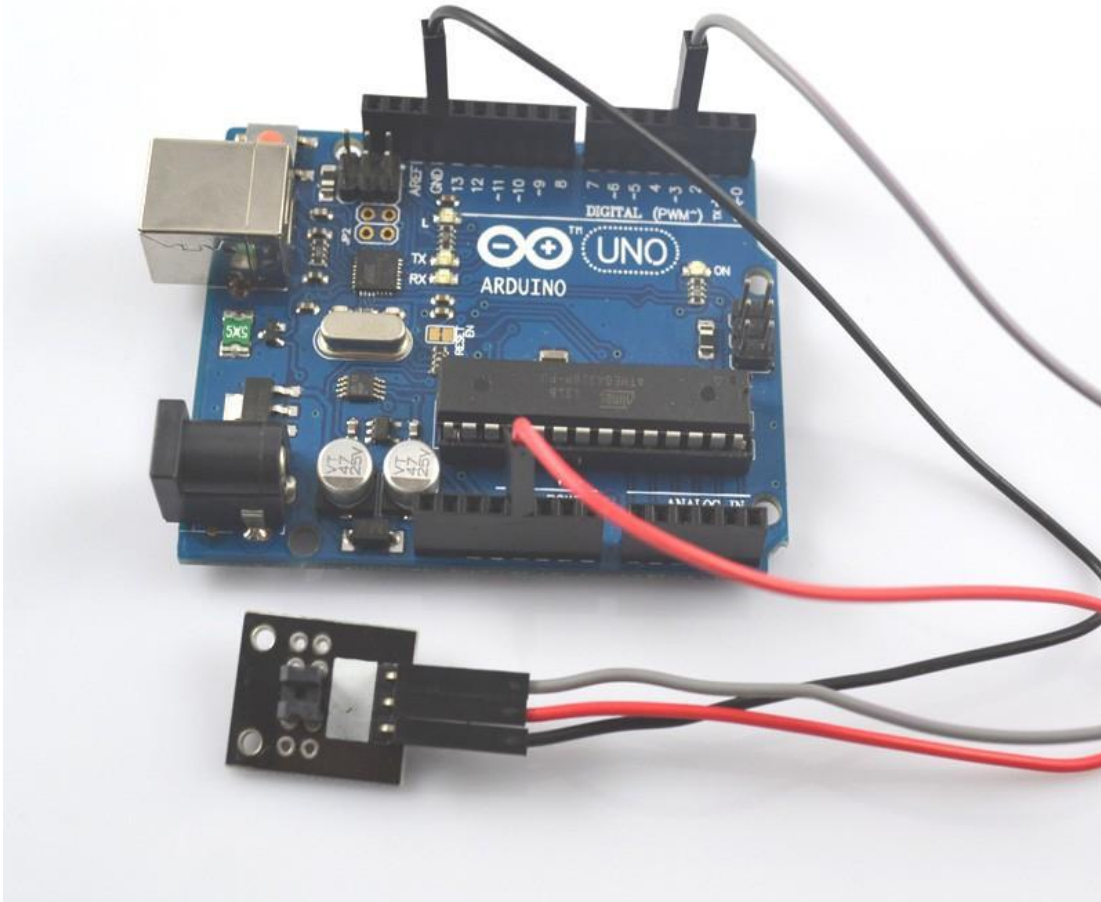

Step 2: Program (please refer to the example code on the CD or official website)

Step 3: Compile the program

Step 4: Burn the program into RobotLinking Uno board

Experimental Summary

Photo-interrupter MODULE is a very simple, very practical technology that is surprisingly easy to master. If you feel as though you're struggling, check out our video tutorials on www.RobotLinking.com or ask us questions on our forum.

Lesson 11 Mercury Switch

Introduction

In this experiment, we will learn how to use Mercury Switch

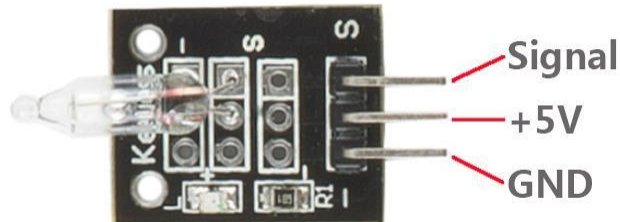

Components

- 1 * RobotLinking Uno board
- 1 * USB cable
- 1 * Mercury Switch
- DuPont wires(Female to Male)

Principle

Mercury Switch and number 13 port have the built-in LED simple circuit. To produce a switch flasher, we can use connect the digital port 13 to the built-in LED and connect the Mercury Switch S port to number 3 port of RobotLinking Uno board. When the tilt switch sensing, LED twinkle light to the switch signal.

Experimental Procedures

Step 1: Connect circuit as shown in the following photo:

The power cord, ground wire and S port of switch module connected to the Arduino board experiment of +5v, GND and 3 port.

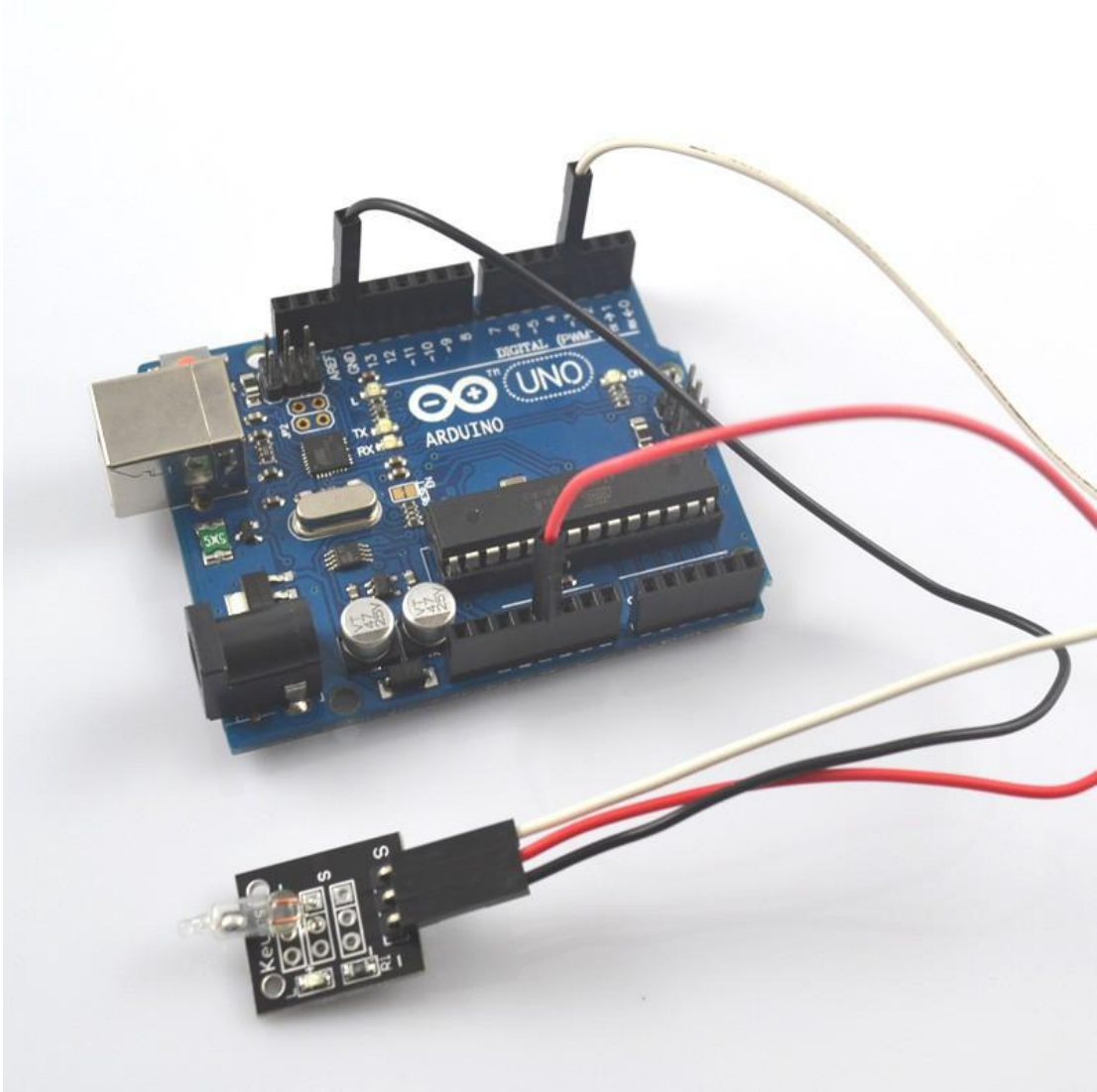

Step 2: Program (please refer to the example code on the CD or official website)

Step 3: Compile the program

Step 4: Burn the program into RobotLinking Uno board

Experimental Summary

Mercury Switch is a very simple, very practical technology that is surprisingly easy to master. If you feel as though you're struggling, check out our video tutorials on www.RobotLinking.com or ask us questions on our forum.

Lesson 12 Tilt SWITCH MODULE

Introduction

In this experiment, we will learn how to use Tilt SWITCH MODULE.

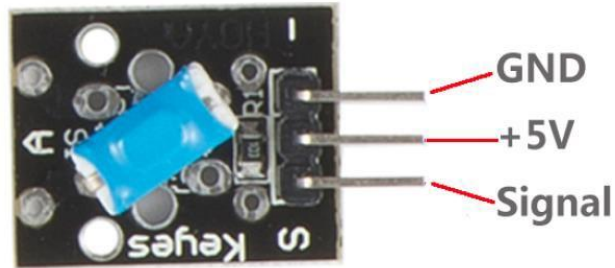

Components

- 1 * RobotLinking Uno board
- 1 * USB cable
- 1 * tilt switch module
- DuPont wires(Female to Male)

Principle

Tilt switch module and number 13 port have the built-in LED simple circuit. To produce a switch flasher, we can use connect the digital port 13 to the built-in LED and connect the Tilt SWITCH MODULE S port to number 3 port of RobotLinking Uno board. When the switch sensing, LED twinkle light to the switch signal.

Experimental Procedures

Step 1: Connect circuit as shown in the following photo:

The power cord, ground wire and S port of switch module connected to the Arduino board experiment of +5v, GND and 3 port.

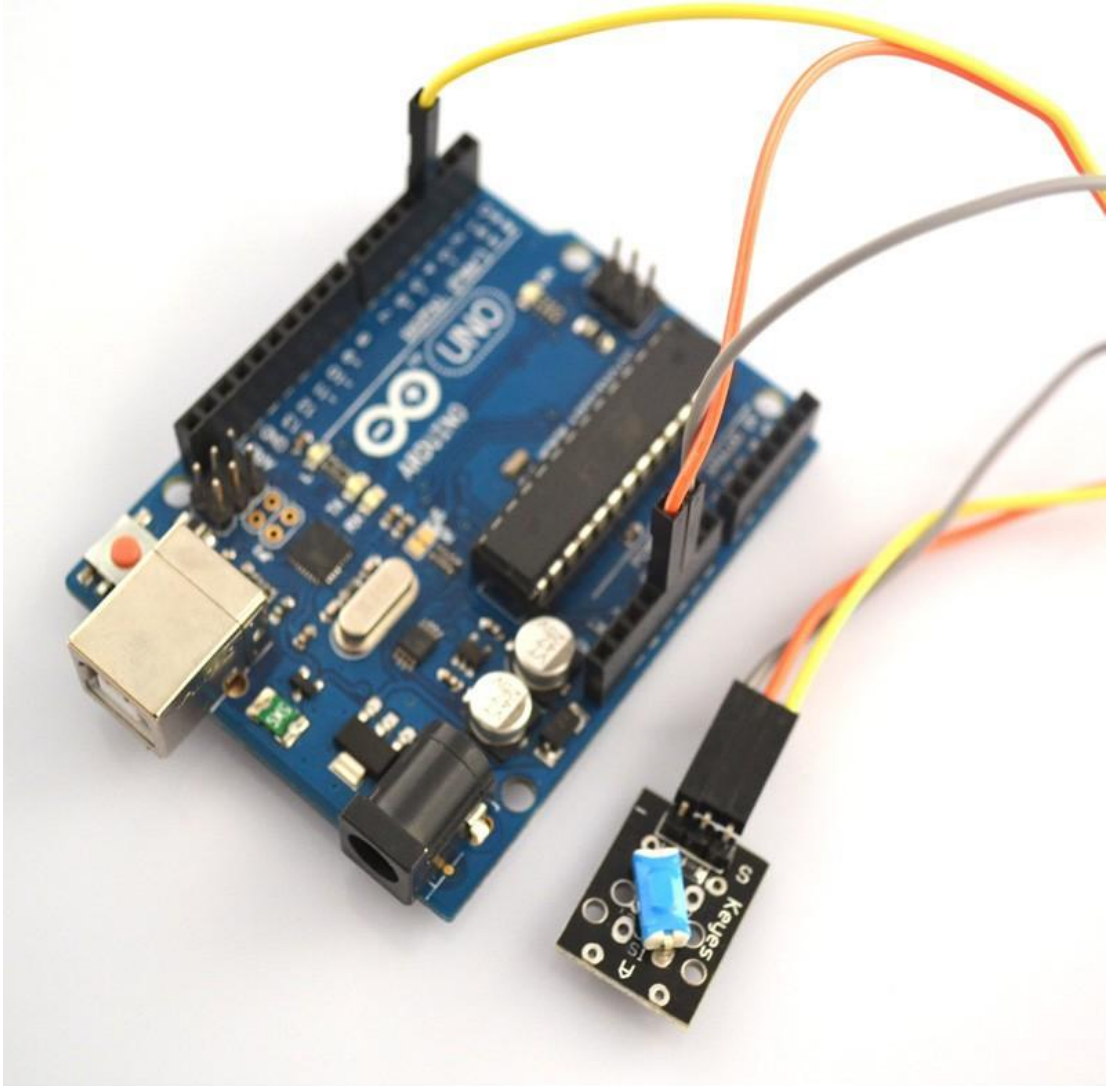

Step 2: Program (please refer to the example code on the CD or official website)

Step 3: Compile the program

Step 4: Burn the program into RobotLinking Uno board

Experimental Summary

Tilt SWITCH MODULE is a very simple, very practical technology that is surprisingly easy to master. If you feel as though you're struggling, check out our video tutorials on www.RobotLinking.com or ask us questions on our forum.

Lesson 13 REED SWITCH AND MINI REED SWITCH MODULE

Introduction

In this experiment, we will learn how to use reed switch and mini reed switch module.

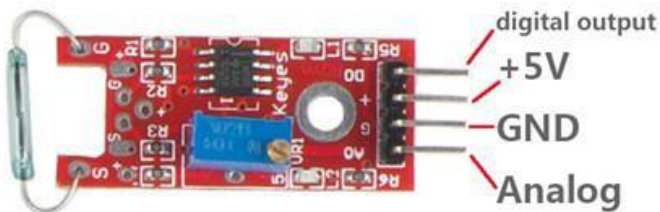

Reed Switch

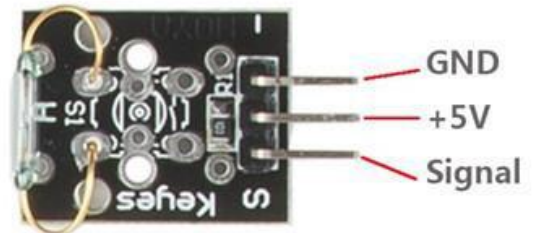

Mini Reed

Components

- 1 * RobotLinking Uno board
- 1 * USB cable
- 1 * reed switch
- 1 * mini reed switch
- DuPont wires(Female to Male)

Principle

reed switch and mini switch module and number 13 port have the built-in LED simple circuit. To produce a switch flasher, we can use connect the digital port 13 to the built-in LED and connect the switch module S port to number 3 port of RobotLinking Uno board. When the switch sensing, LED twinkle light to the switch signal.

Experimental Procedures

Step 1: Connect circuit as shown in the following photo:

The power cord, ground wire and S port of switch module connected to the Arduino board experiment of +5v, GND and 3 port.

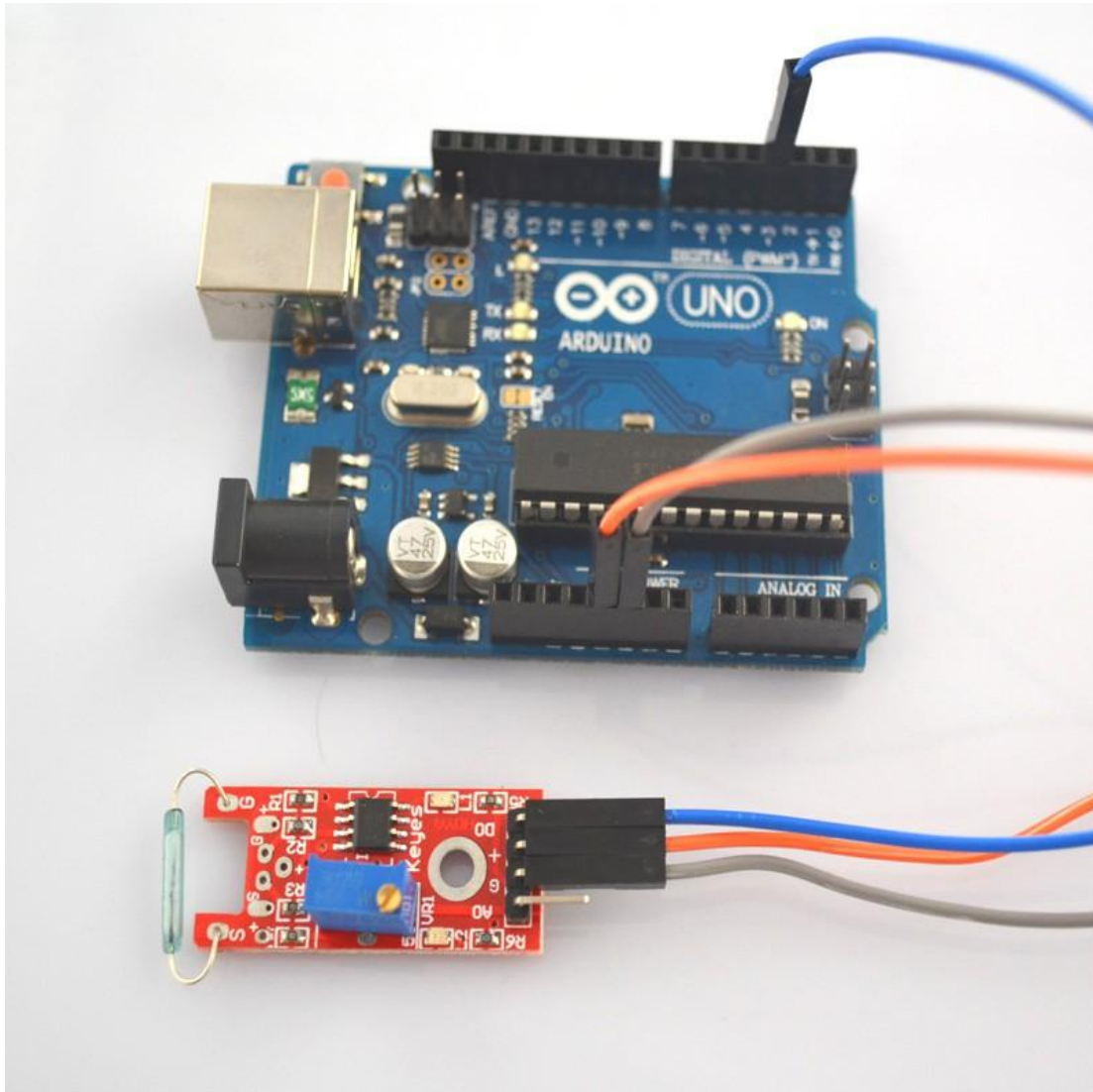

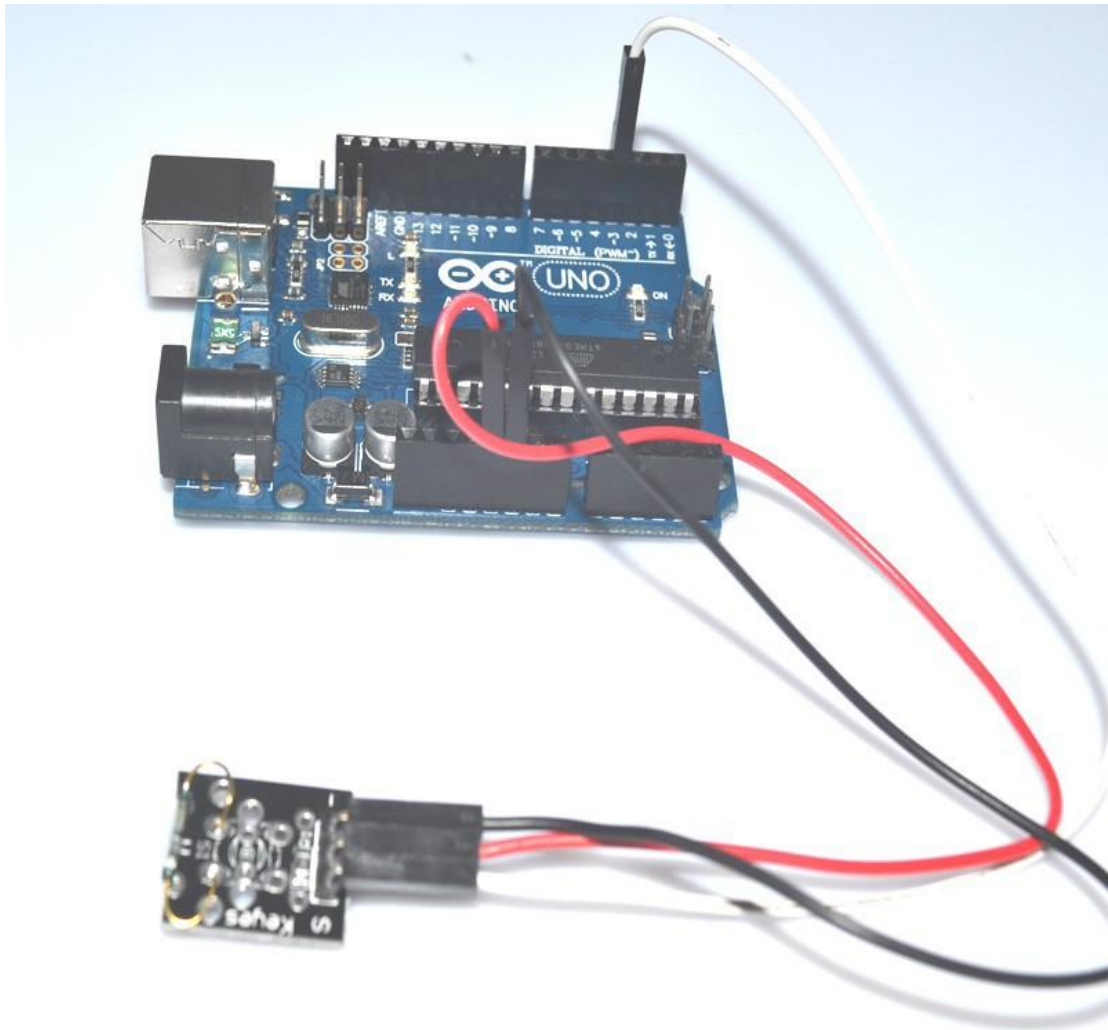

Step 2: Program (please refer to the example code on the CD or official website)

Step 3: Compile the program

Step 4: Burn the program into RobotLinking Uno board

Experimental Summary

Reed switch and mini reed switch module are very simple, very practical technology that is surprisingly easy to master. If you feel as though you're struggling, check out our video tutorials on www.RobotLinking.com or ask us questions on our forum.

Lesson 14 Dual-color Common-Cathode LED

Introduction

In this experiment, we will learn how to use Dual-color Common-Cathode LED.



Components

- 1 * RobotLinking Uno board
- 1 * USB cable
- 1 * Dual-color Common-Cathode LED
- DuPont wires(Female to Male)

Experimental Procedures

Step 1: Connect circuit as shown in the following photo:

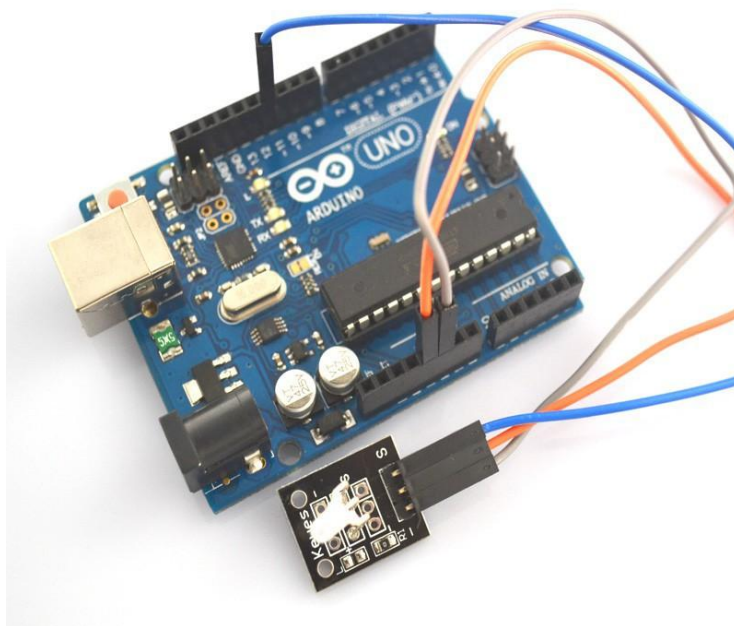

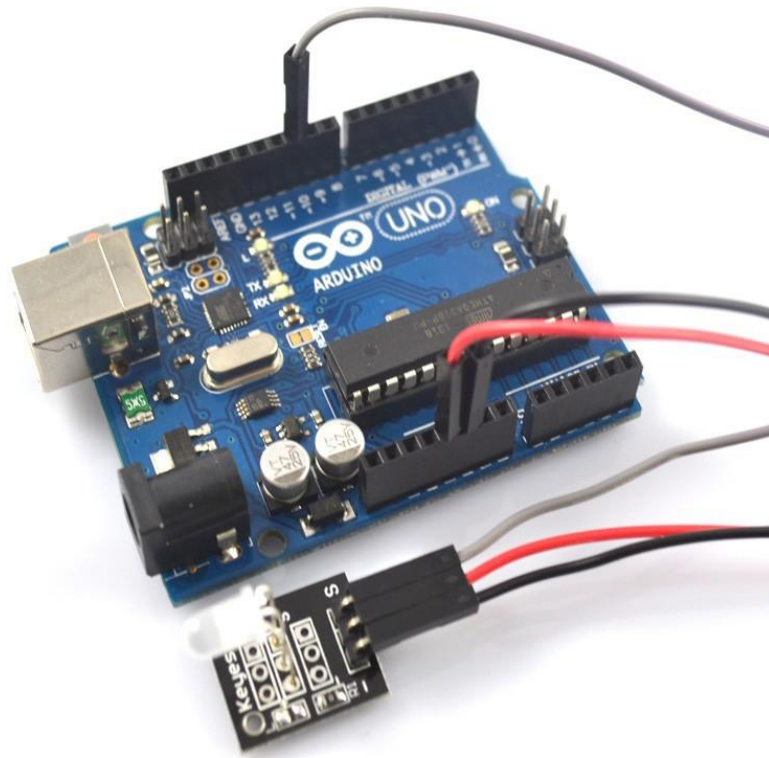

Step 2: Program (please refer to the example code on the CD or official website)

Step 3: Compile the program

Step 4: Burn the program into RobotLinking Uno board

Experimental Summary

Dual-color Common-Cathode LED is a very simple, very practical technology that is surprisingly easy to master. If you feel as though you're struggling, check out our video tutorials on www.RobotLinking.com or ask us questions on our forum.

Lesson 15 Knock Sensor

Introduction

In this experiment, we will learn how to use Knock Sensor.

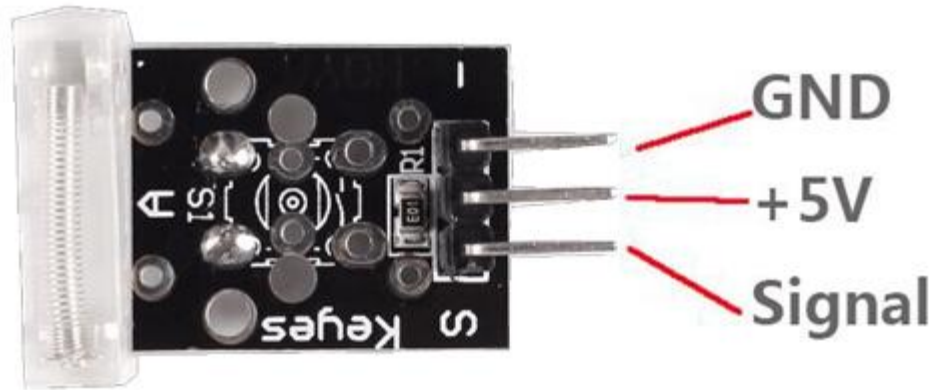

Components

- 1 * RobotLinking Uno board
- 1 * USB cable
- 1 * Knock Sensor
- DuPont wires(Female to Male)

Principle

Knock Sensor and number 13 port have the built-in LED simple circuit. To produce a switch flasher, we can use connect the digital port 13 to the built-in LED and connect the Knock Sensor module S port to number 3 port of RobotLinking Uno board. When the switch sensing, LED twinkle light to the switch signal.

Experimental Procedures

Step 1: Connect circuit as shown in the following photo:

The power cord, ground wire and S port of switch module connected to the Arduino board experiment of +5v, GND and 3 port.

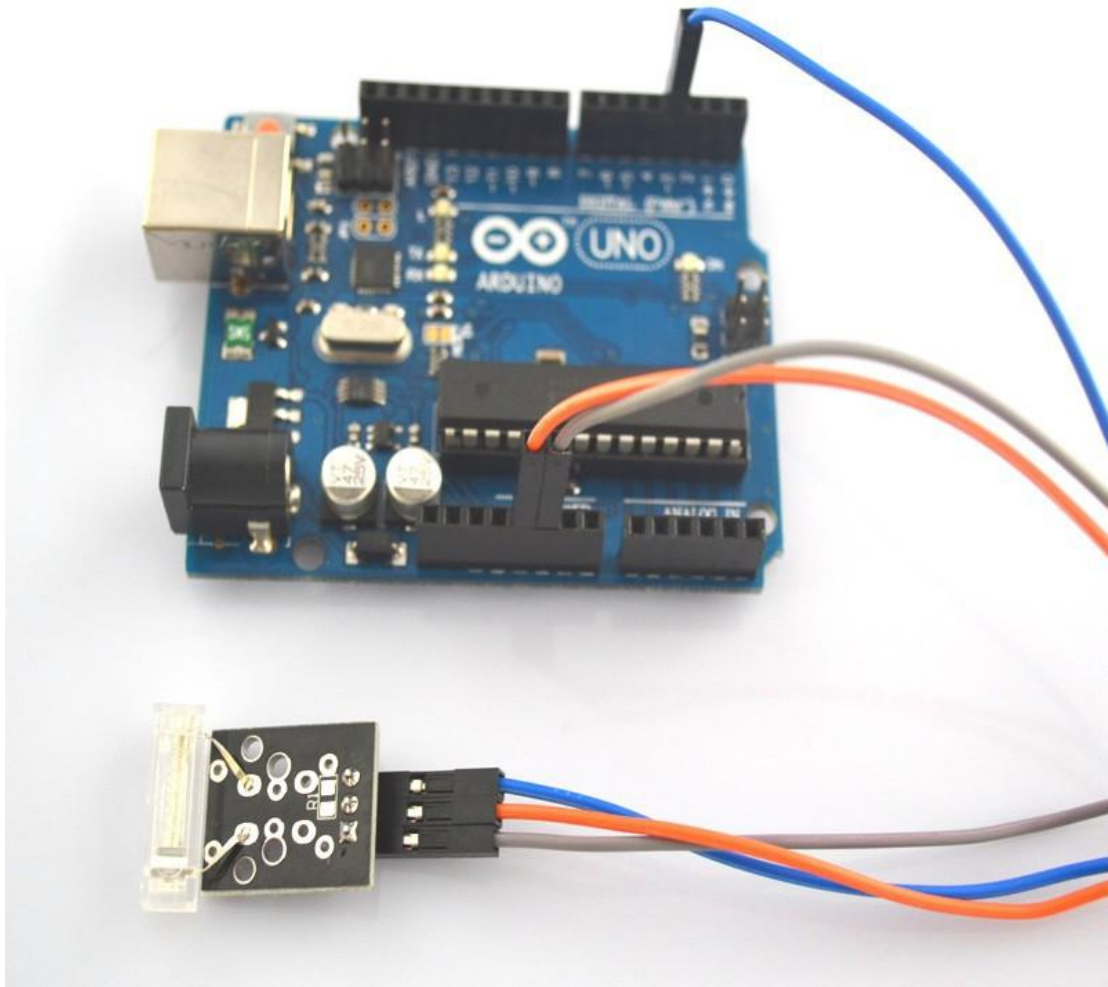

Step 2: Program (please refer to the example code on the CD or official website)

Step 3: Compile the program

Step 4: Burn the program into RobotLinking Uno board

Experimental Summary

Knock Sensor is a very simple, very practical technology that is surprisingly easy to master. If you feel as though you're struggling, check out our video tutorials on www.RobotLinking.com or ask us questions on our forum.

Lesson 16 DIGITAL TEMPERATURE MODULE

Introduction

In this experiment, we will learn how to use digital temperature module.

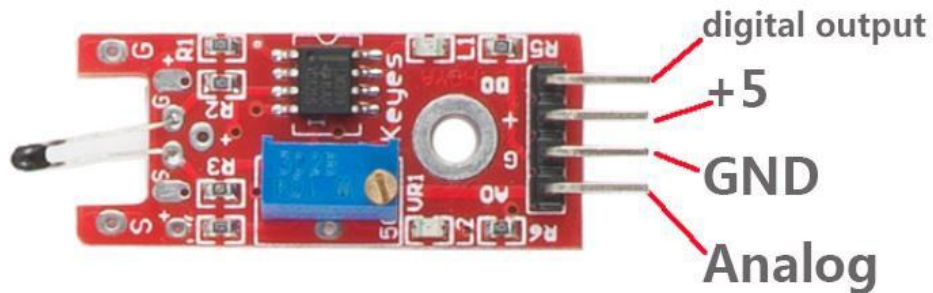

Components

- 1 * RobotLinking Uno board
- 1 * USB cable
- 1 * digital temperature module
- DuPont wires(Female to Male)

Principle

Digital temperature module and number 13 port have the built-in LED simple circuit. To produce a temperature flasher, we can use connect the digital port 13 to the built-in LED and connect the temperature module S port to number 3 port of RobotLinking Uno board. When the temperature sensing, LED twinkle light to the module signal.

Experimental Procedures

Step 1: Connect circuit as shown in the following photo:

The power cord, ground wire and S port of digital temperature module connected to the Arduino board experiment of +5v, GND and 3 port.

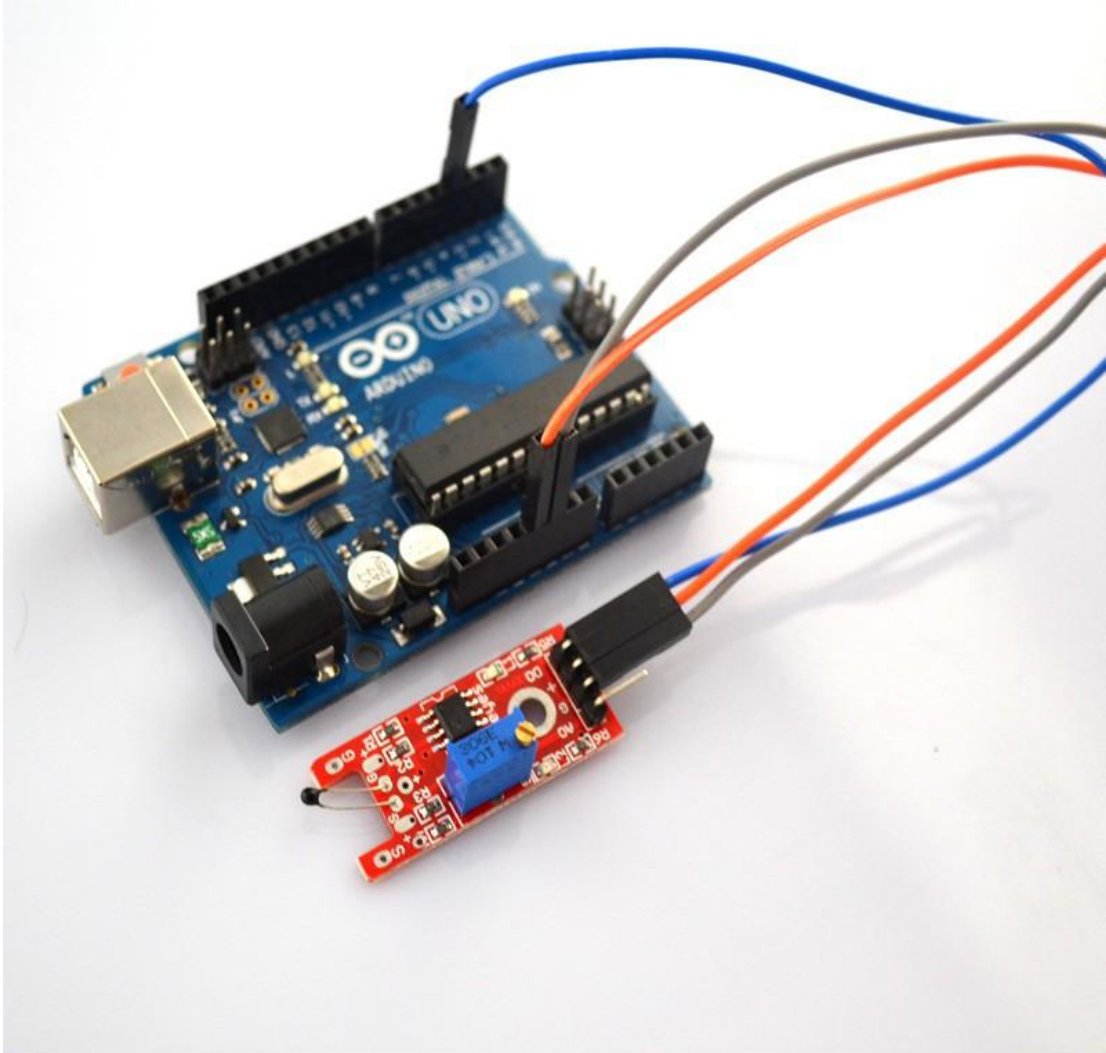

Step 2: Program (please refer to the example code on the CD or official website)

Step 3: Compile the program

Step 4: Burn the program into RobotLinking Uno board

Experimental Summary

Digital temperature module is a very simple, very practical technology that is surprisingly easy to master. If you feel as though you're struggling, check out our video tutorials on www.RobotLinking.com or ask us questions on our forum.

Lesson 17 FLAME SENSOR MODULE

Introduction

In this experiment, we will learn how to use the flame sensor module.

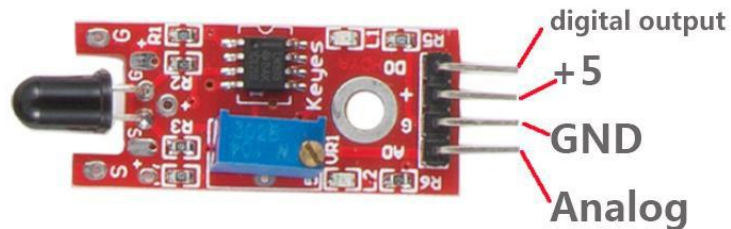

Components

- 1 * RobotLinking Uno board
- 1 * USB cable
- 1 * flame sensor module
- DuPont wires(Female to Male)

Principle

Flame sensor module and number 13 port have the built-in LED simple circuit. To produce a flame sensing flasher, we can use connect the digital port 13 to the built-in LED and connect the flame sensor module S port to number 3 port of RobotLinking Uno board. When the flame sensor module sensing fire, LED twinkle light to the module signal.

Experimental Procedures

Step 1: Connect circuit as shown in the following photo:

The power cord, ground wire and S port of flame sensor module connected to the Arduino board experiment of +5v, GND and 3 port.

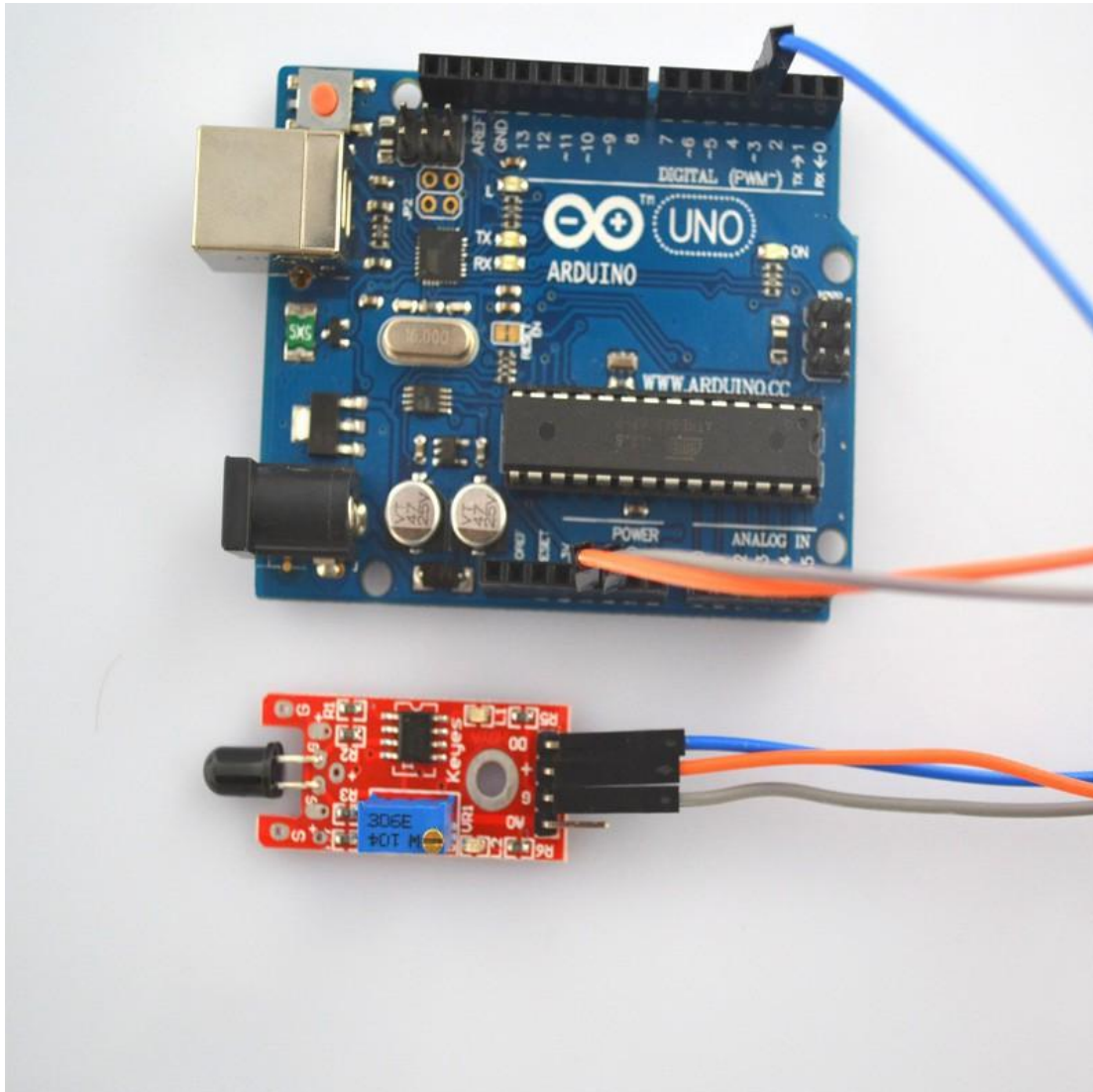

Step 2: Program (please refer to the example code on the CD or official website)

Step 3: Compile the program

Step 4: Burn the program into RobotLinking Uno board

Experimental Summary

Flame sensor module are a very simple, very practical technology that is surprisingly easy to master. If you feel as though you're struggling, check out our video tutorials on www.RobotLinking.com or ask us questions on our forum.

Lesson 18 MENTAL TOUCH MODULE

Introduction

In this experiment, we will learn how to use the mental touch module.

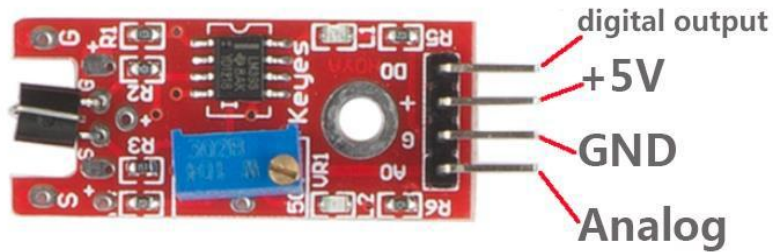

Components

- 1 * RobotLinking Uno board
- 1 * USB cable
- 1 * mental touch module
- DuPont wires(Female to Male)

Principle

Mental touch module and number 13 port have the built-in LED simple circuit. To produce a mental touch sensing flasher, we can use connect the digital port 13 to the built-in LED and connect the mental touch module S port to number 3 port of RobotLinking Uno board. When the touch module sensing touch, LED twinkle light to the module signal.

Experimental Procedures

Step 1: Connect circuit as shown in the following photo:

The power cord, ground wire and S port of mental touch module connected to the Arduino board experiment of +5v, GND and 3 port.

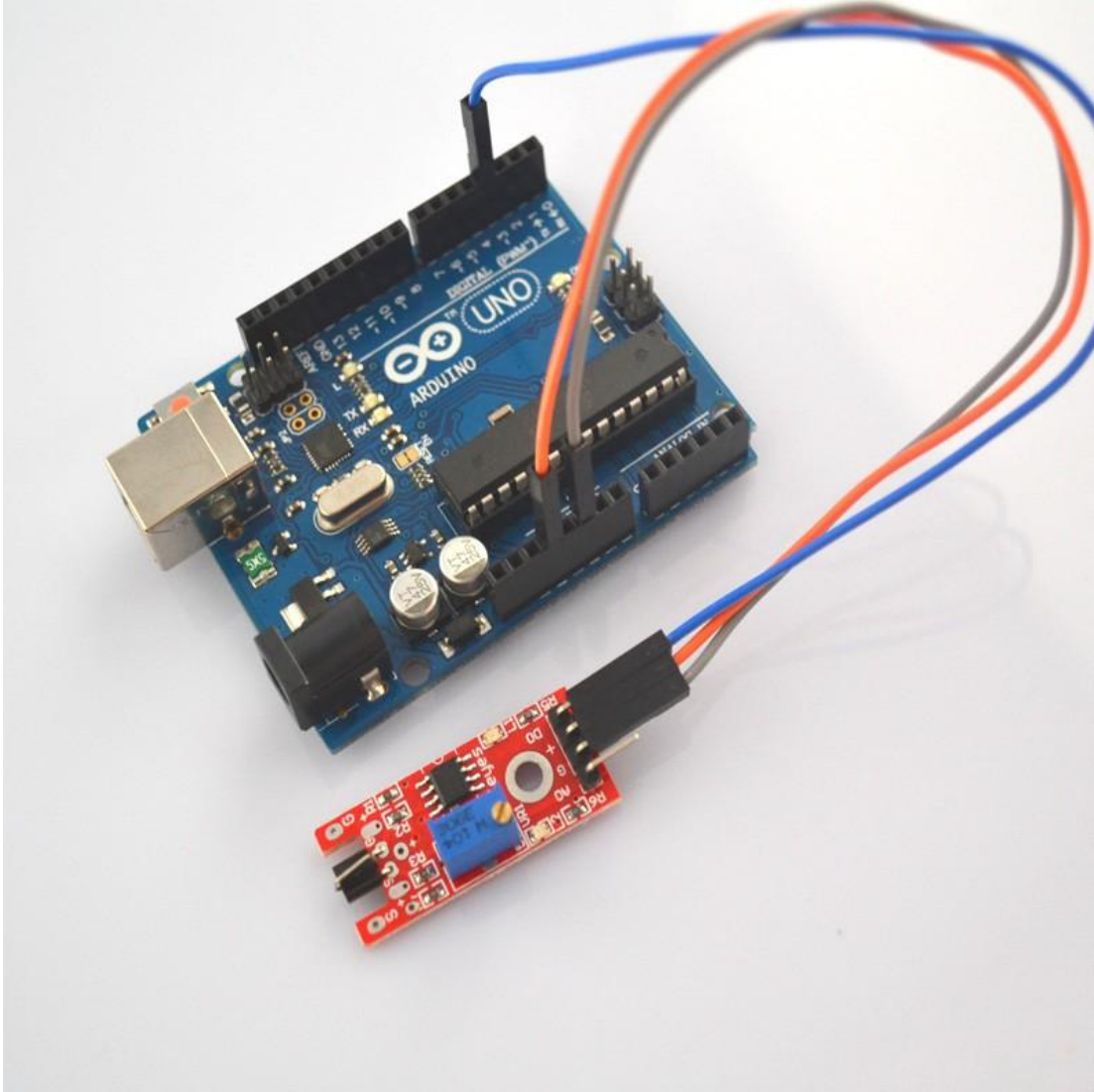

Step 2: Program (please refer to the example code on the CD or official website)

Step 3: Compile the program

Step 4: Burn the program into RobotLinking Uno board

Experimental Summary

Mental touch module is a very simple, very practical technology that is surprisingly easy to master. If you feel as though you're struggling, check out our video tutorials on www.RobotLinking.com or ask us questions on our forum.

Lesson 19 ANALOG TEMP MODULE

Introduction

In this experiment, we will learn how to use the analog temp module.

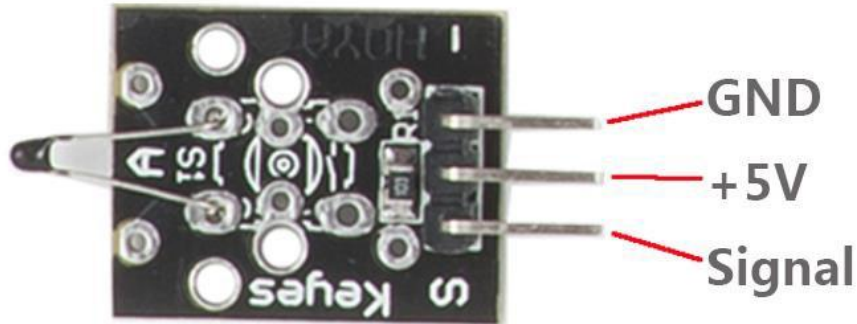

Components

- 1 * RobotLinking Uno board
- 1 * USB cable
- 1 * analog temp module
- DuPont wires(Female to Male)

Principle

The module is based on a thermistor (resistance varies with temperature change and environment), the working principle of the real time perception surrounding the change of environmental temperature, we send the data to the Arduino analog I/o, we just came through a simple programming can convert the sensor output data to degrees Celsius temperature, and shows that is convenient to use, effective, to widely used in gardening, home alarm system and other devices.

Experimental Procedures

Step 1: The corresponding schematic diagram is as follows:

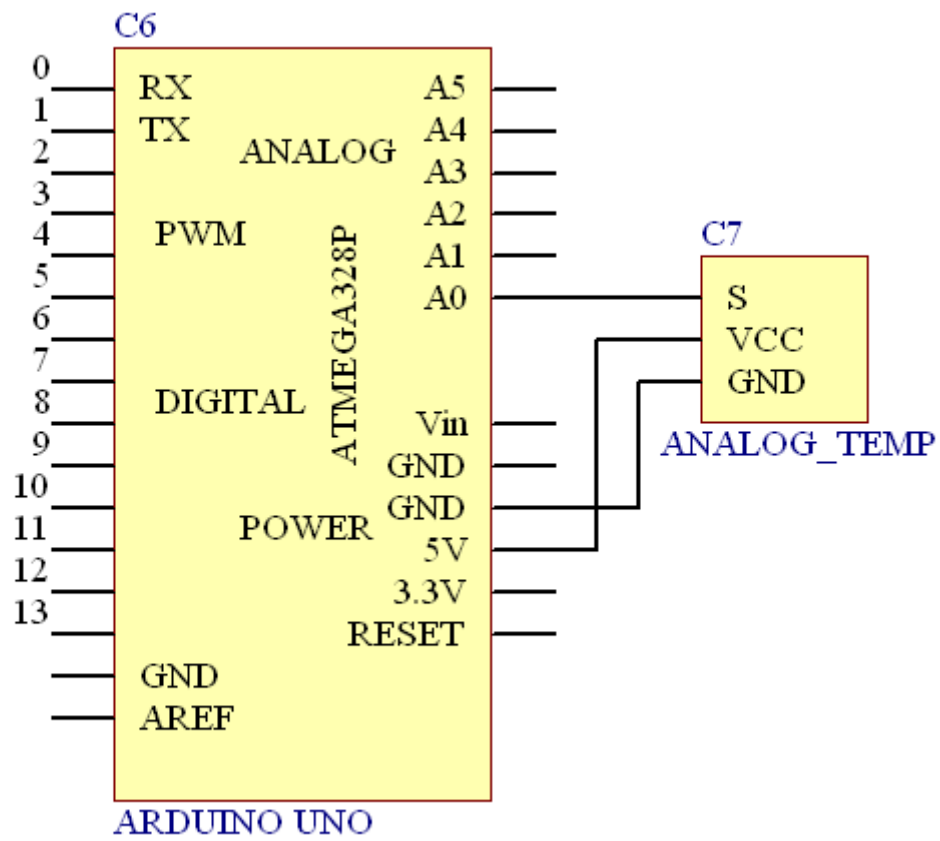

Step 2: Connect circuit as shown in the following photo:

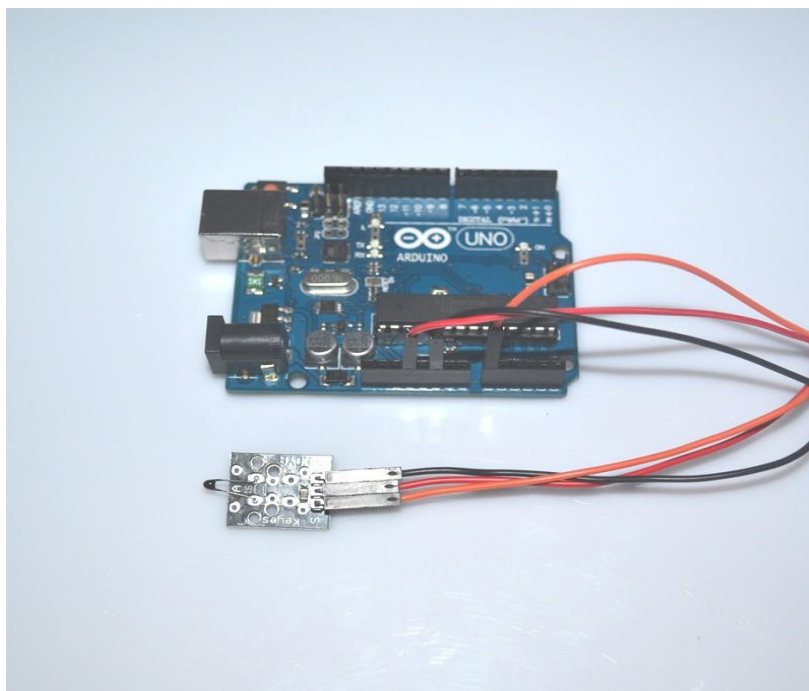

Step 3: Program (please refer to the example code on the CD or official website)

Step 4: Compile the program

Step 5: Burn the program into RobotLinking Uno board

Step 6: Open the TOOL→Serial Monitor, and we can see the data as below:

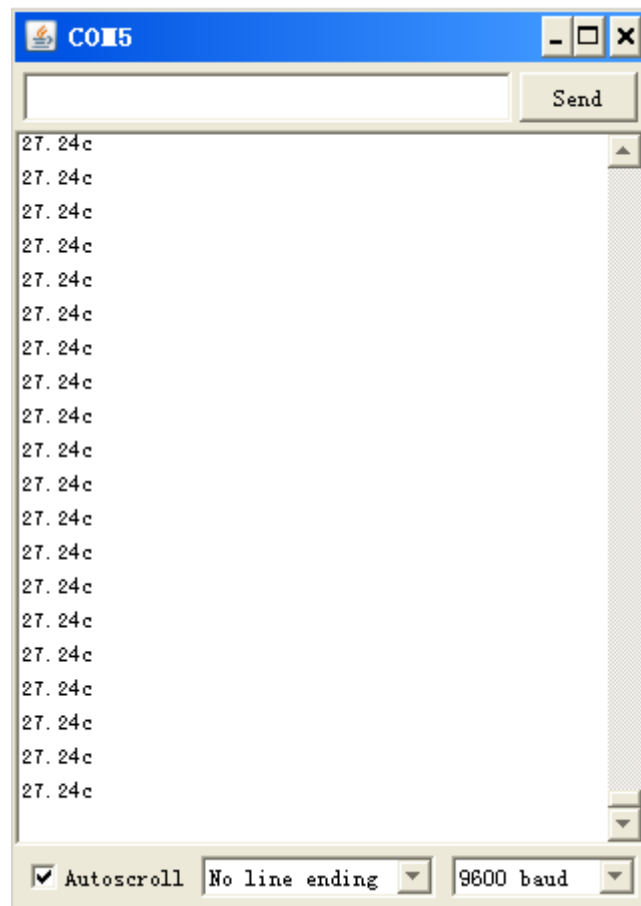

Experimental Summary

ANALOG TEMP module is a very simple, very practical technology that is surprisingly easy to master. If you feel as though you're struggling, check out our video tutorials on www.RobotLinking.com or ask us questions on our forum.

Lesson 20 PHOTORESISTOR MODULE

Introduction

In this experiment, we will learn how to use the photo-resistor module.

Photo-resistor is very common in our daily life. it is mainly used in intelligent switch so as to bring convenience to our life. At the same time, in our daily life, we also use it in electronic design. So in order to use it in a better, we provide the corresponding modules to help us to use it more conveniently and efficiently.

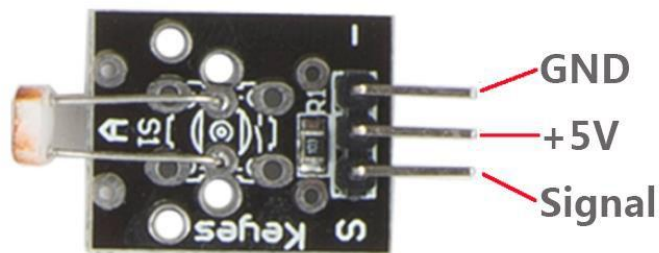

Components

- 1 * RobotLinking Uno board
- 1 * USB cable
- 1 * photo-resistor module
- DuPont wires(Female to Male)

Principle

Photo-resistor module is a photosensitive semiconductor device. In addition to high sensitivity, fast response, spectral characteristics and same r value, it can maintain a high level of stability and reliability in the high temperature, wet and bad environment. It can be widely apply in the camera, solar garden lamp, lawn lamp, counterfeit detector, quartz clock, music cup, gift boxes, mini night light, street lamp automatic switch and all kinds of electric toys, electric lighting, lamps and lanterns, and other areas of the light automatically on-off controller area.

Experimental Procedures

Step 1: The corresponding schematic diagram is as follows:

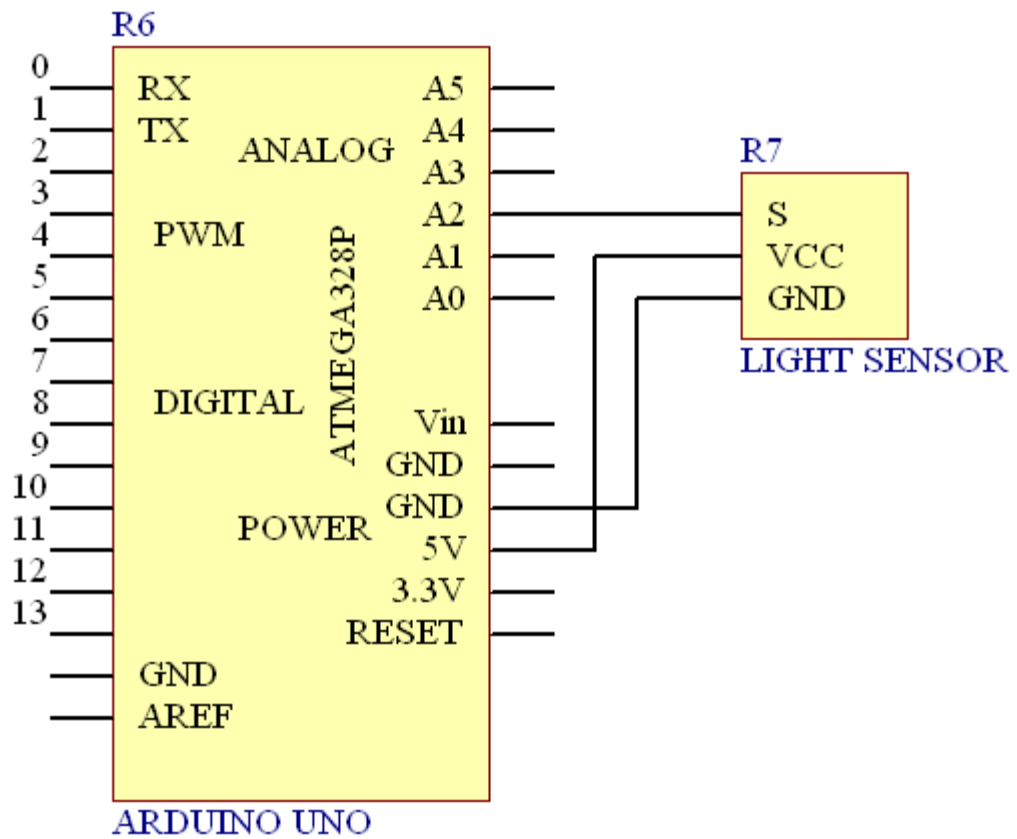

Step 2: Connect circuit as shown in the following photo:

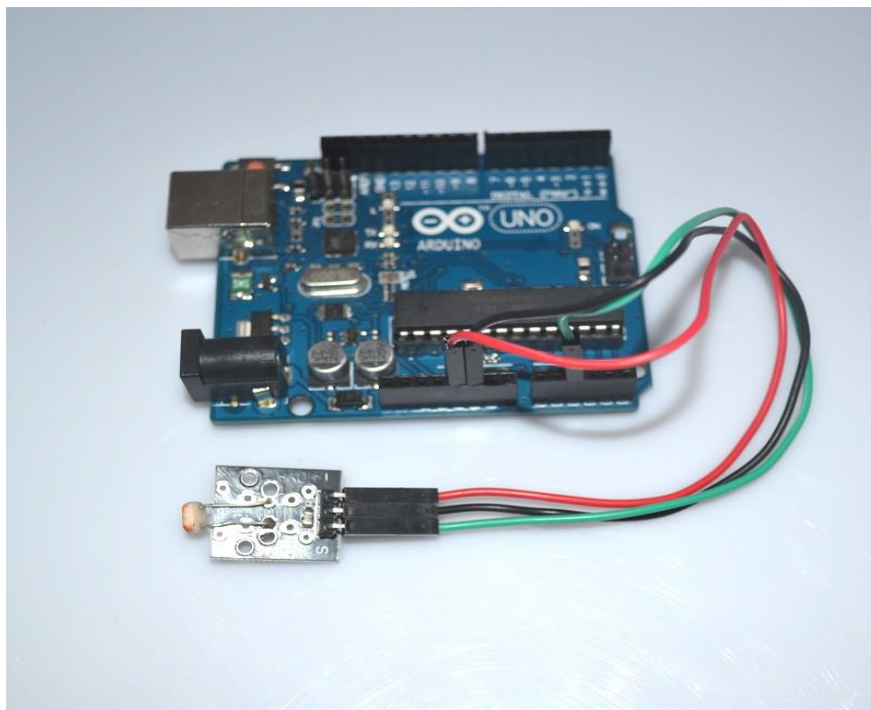

Step 3: Program (please refer to the example code on the CD or official website)

Step 4: Compile the program

Step 5: Burn the program into RobotLinking Uno board

Step 6: Open the TOOL→Serial Monitor, and we can see the data as below:

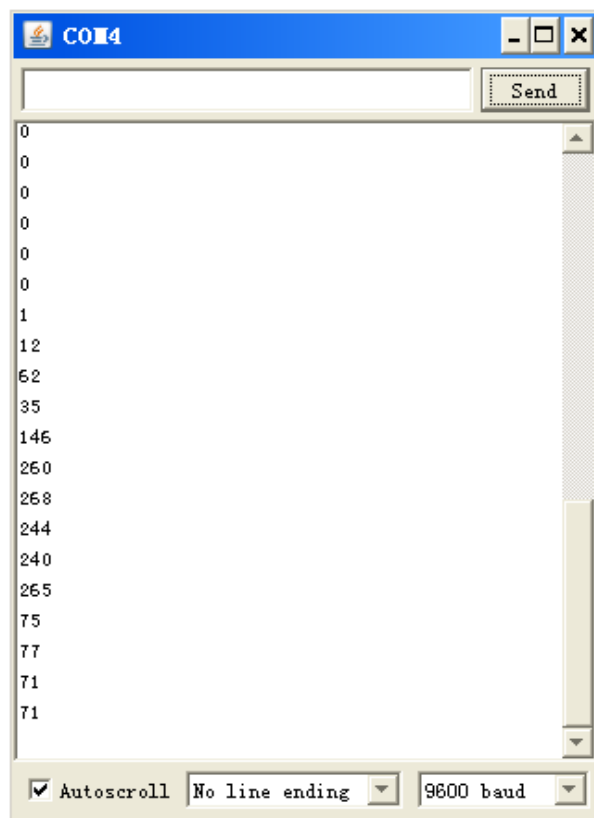

Experimental Summary

In the test, we only read the output analog voltage value of photo-resistor module. In the test results, we will find that when there is lighting, high voltage output equivalently of switch on, when there is no light, low voltage equivalently of switch off. This is what we can use this in practice.

If you feel as though you're struggling, check out our video tutorials on www.RobotLinking.com or ask us questions on our forum.

Lesson 21 7 COLOR FLASH LED MODULE

Introduction

In this experiment, we will learn how to use the 7 color flash LED module.

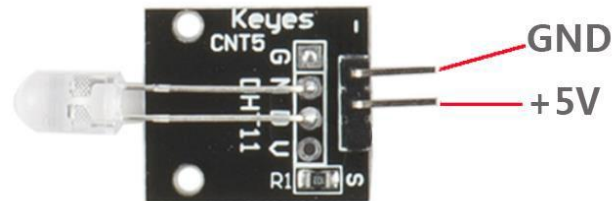

Components

- 1 * RobotLinking Uno board
- 1 * USB cable
- 1 * 7 color flash LED module
- DuPont wires(Female to Male)

Principle

the product type: light-emitting diodes

product model: b4pnyg YB-3120-PM

the product shape: straight plug type 5 mm round hair light diode

light color: pink yellow green (high brightness)

lens type: white mist

standard forward voltage: 3.0-4.5V

Experimental Procedures

Step 1: Connect circuit as shown in the following photo:

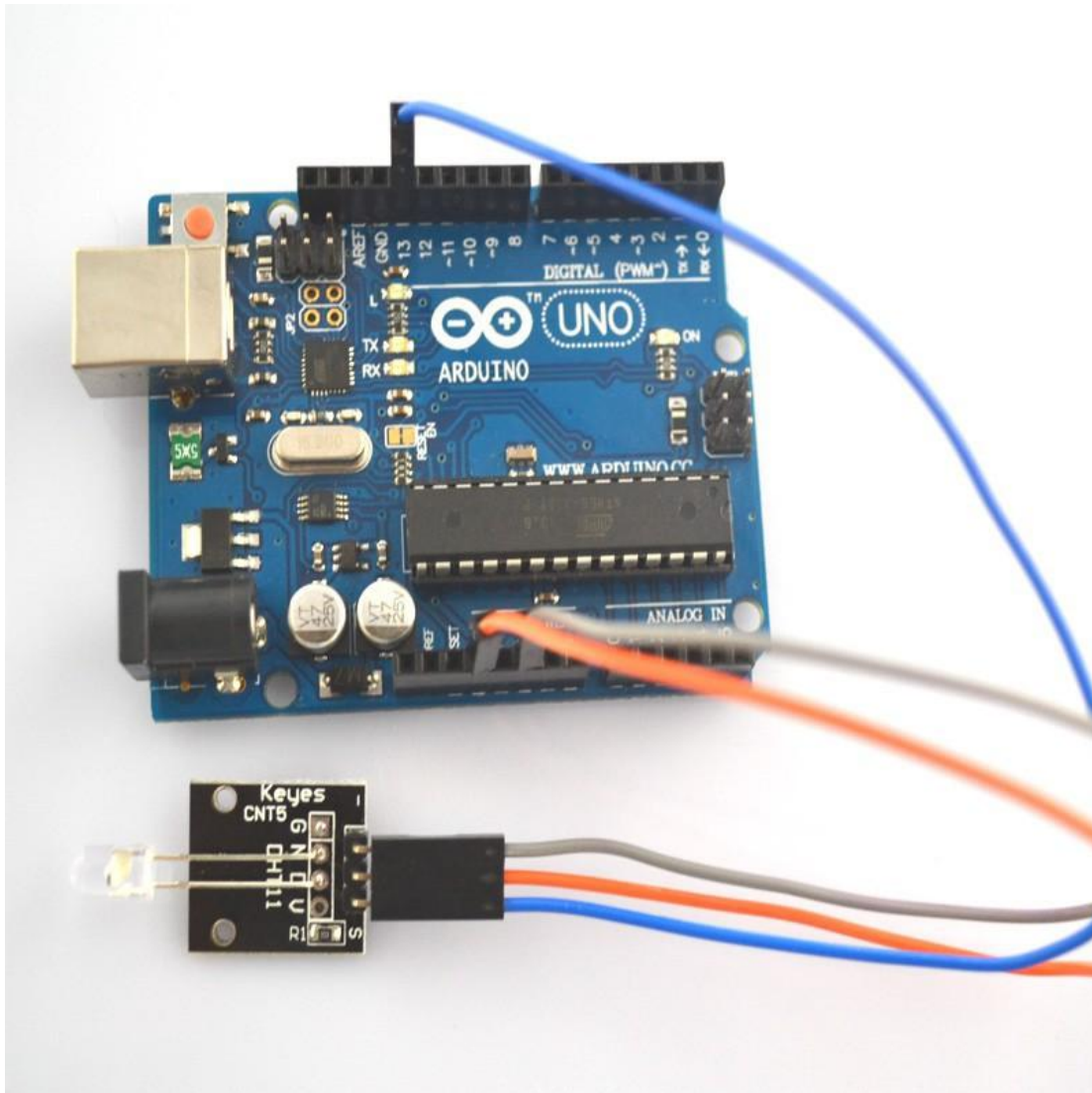

Step 2: Program (please refer to the example code on the CD or official website)

Step 3: Compile the program

Step 4: Burn the program into RobotLinking Uno board

Experimental Summary

7 color flash LED module are a very simple, very practical technology that is surprisingly easy to master. If you feel as though you're struggling, check out our video tutorials on www.RobotLinking.com or ask us questions on our forum.

Lesson 22 High-sensitive Voice Sensor

Introduction

In this experiment, we will learn how to use the High-sensitive Voice Sensor .



High-sensitive Voice Sensor

Components

- 1 * RobotLinking Uno board
- 1 * USB cable
- High-sensitive Voice Sensor
- DuPont wires(Female to Male)

Principle

High-sensitive Voice Sensor has two output:

AO, analog output, real-time output voltage signal of microphone

DO, when the intensity of the sound to reach a certain threshold, the output high and low level signal, the threshold - sensitivity can be achieved by potentiometer adjustment period

The module features:

The installation of 3 mm screw holes

use 5 v dc power supply

have analog output

turn a threshold level of output

microphone Gao Gan degree, high sensitivity.

has a power light

the comparator output indicator light

Experimental Procedures

Digital signal output:

Step 1: Connect circuit as shown in the following photo:

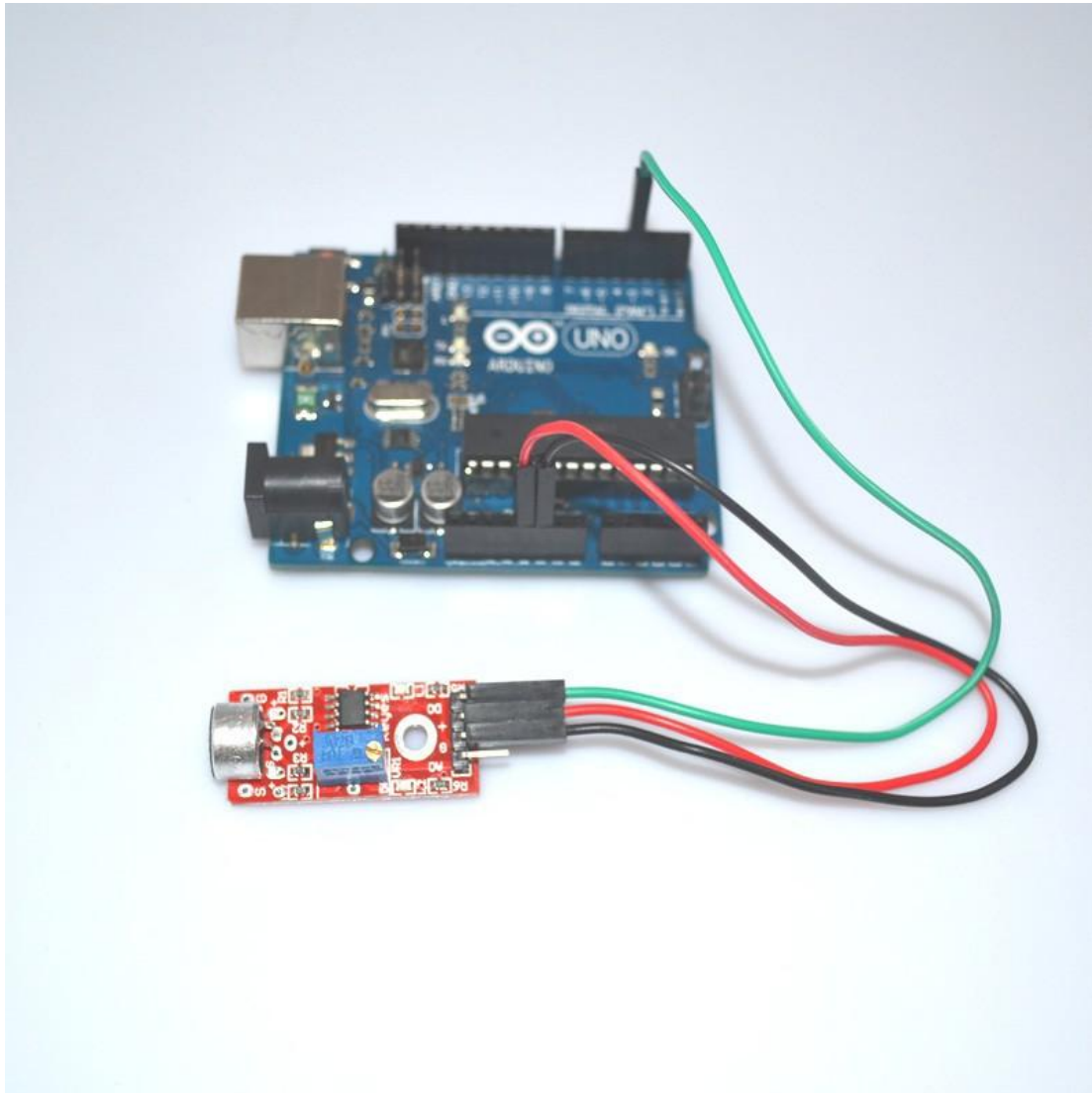

Step 2: Program (please refer to the example code on the CD or official website)

Step 3: Compile the program

Step 4: Burn the program into RobotLinking Uno board

Analog signal output

Step 1: Connect circuit as shown in the following photo:

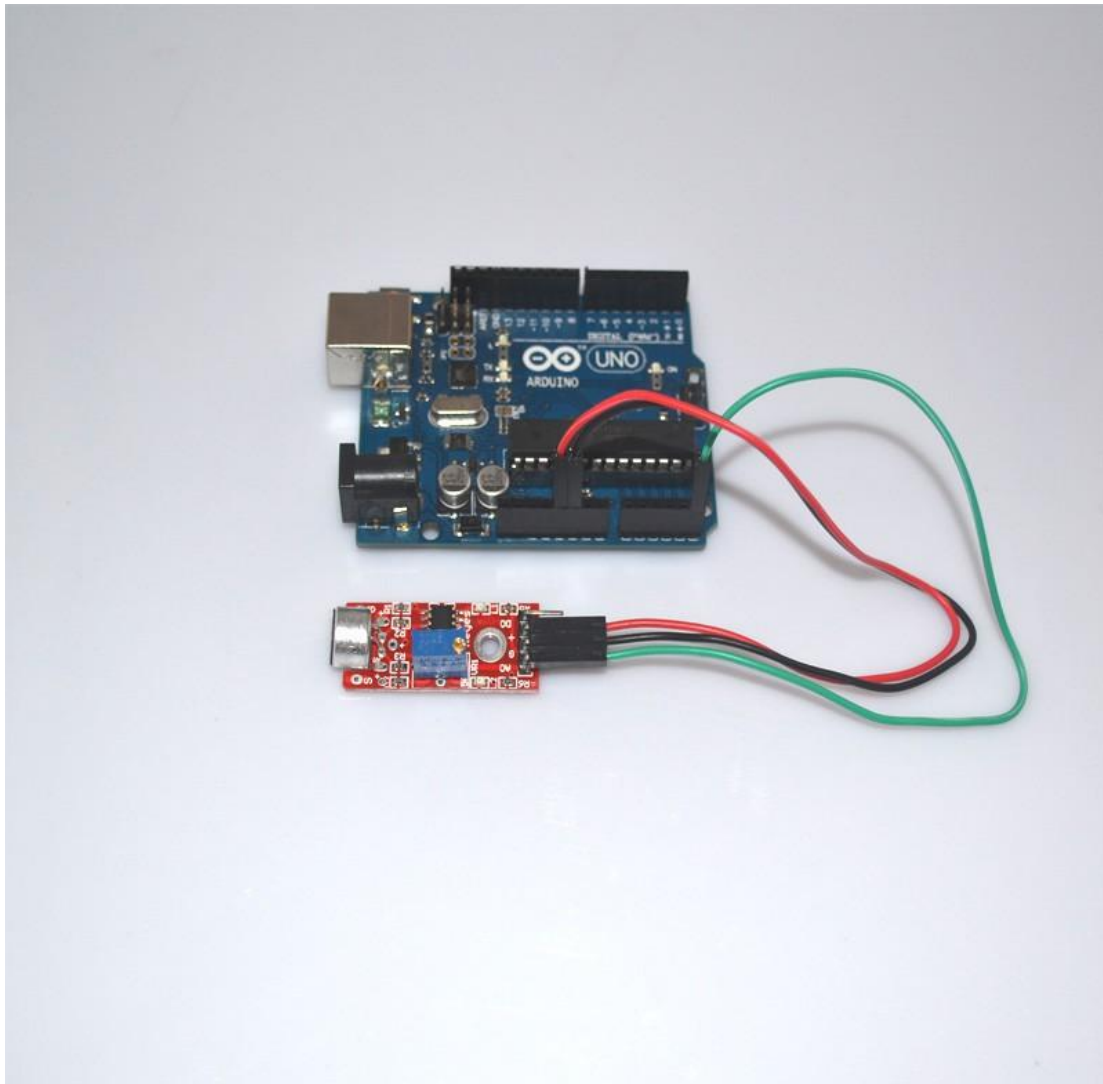

Step 2: Program (please refer to the example code on the CD or official website)

Step 3: Compile the program

Step 4: Burn the program into RobotLinking Uno board

Step 5: Open the TOOL→Serial Monitor, and we can see the data

Experimental Summary

High-sensitive Voice Sensor is a very simple, very practical technology that is surprisingly easy to master. If you feel as though you're struggling, check out our video tutorials on www.RobotLinking.com or ask us questions on our forum.

Lesson 23 Magic light cup MODULE

Introduction

In this experiment, we will learn how to use the light cup module.

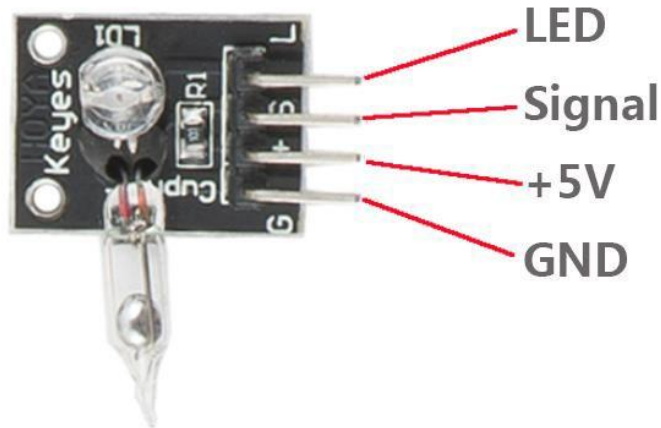

Components

- 1 * RobotLinking Uno board
- 1 * USB cable
- 2 * Magic light cup module
- DuPont wires(Female to Male)

Principle

Magic light cup module is a product which can easily interact with the ARDUINO module, the principle is to use the PWM dimming, change the brightness of the two modules. Mercury switch provides digital signal, trigger PWM adjustment. through the design program, we can see the result which is similar to the effect of two cup full of light pouring to each other.

Experimental Procedures

Step 1: Connect circuit as shown in the following photo:

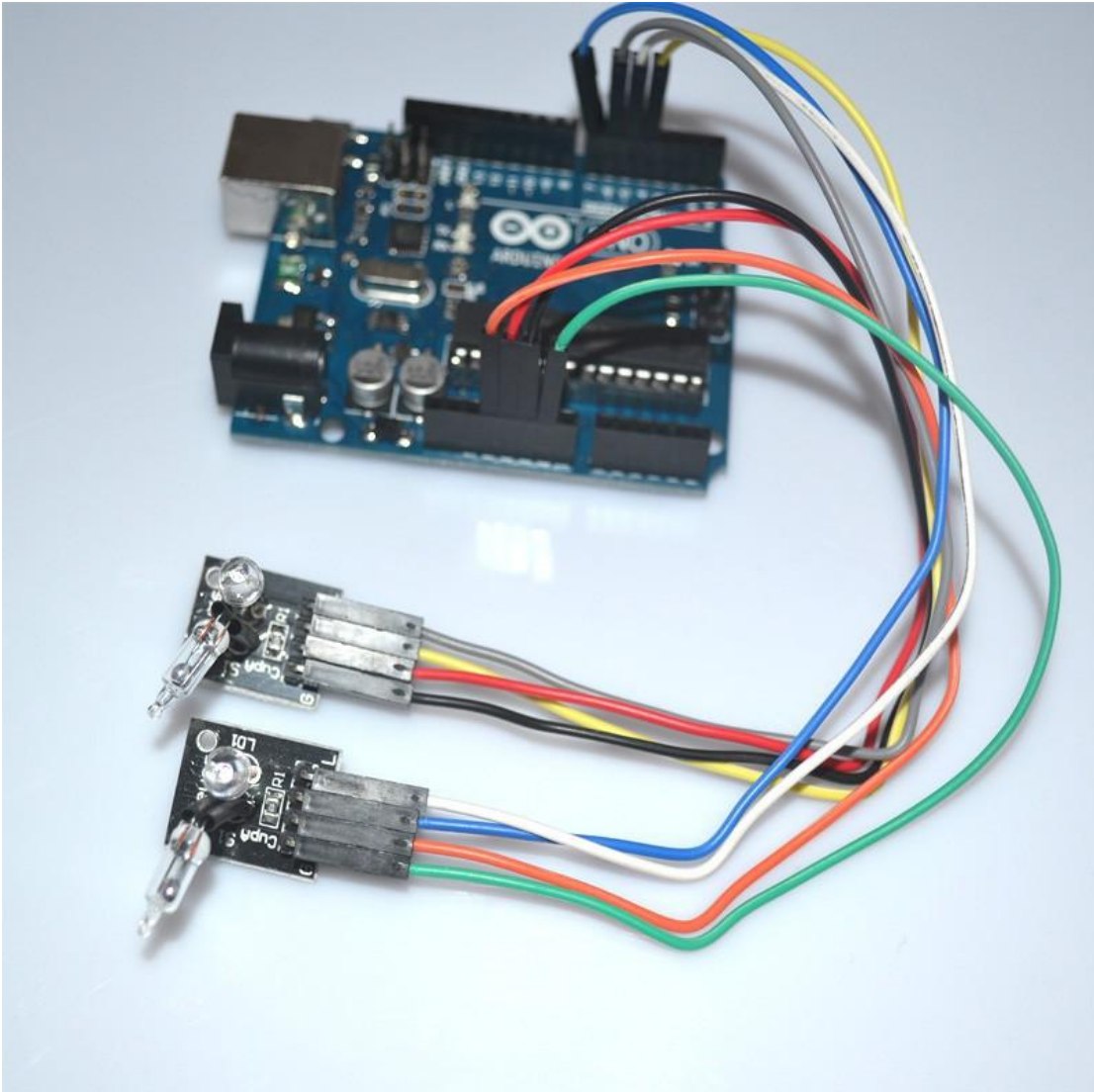

Step 2: Program (please refer to the example code on the CD or official website)

Step 3: Compile the program

Step 4: Burn the program into RobotLinking Uno board

Experimental Summary

Magic light cup module is a very simple, very practical technology that is surprisingly easy to master. If you feel as though you're struggling, check out our video tutorials on www.RobotLinking.com or ask us questions on our forum.

Lesson 24 JOYSTICK MODULE

Introduction

In this experiment, we will learn how to use the joystick module.

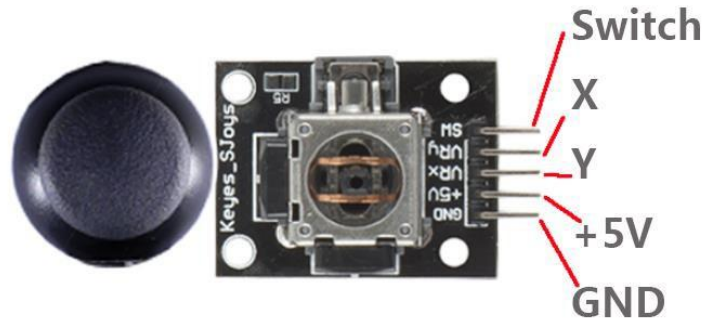

Components

- 1 * RobotLinking Uno board
- 1 * USB cable
- 1 * joystick module
- DuPont wires(Female to Male)

Principle

Experimental Procedures

Step 1: Connect circuit as shown in the following photo:

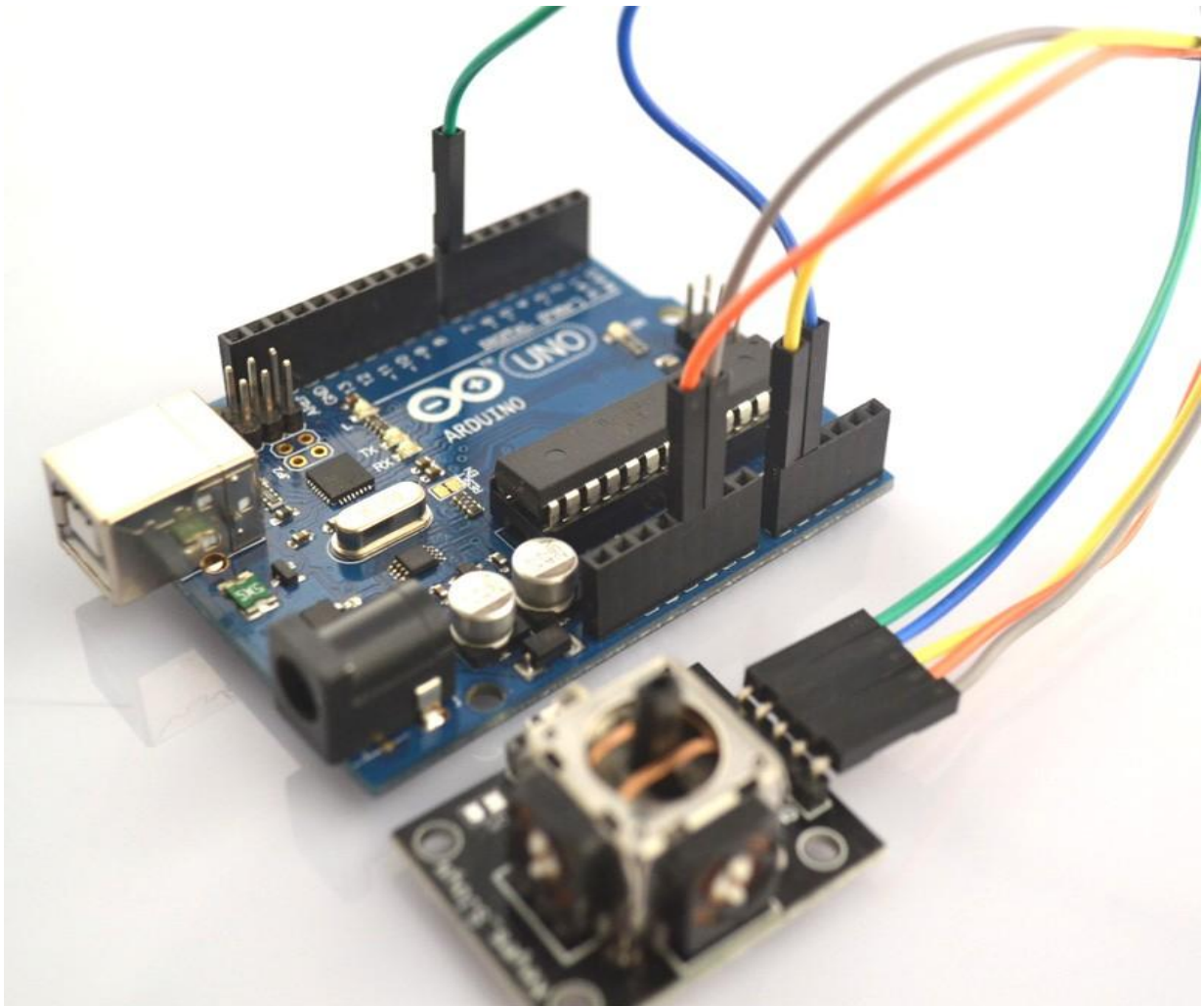

Step 2: Program (please refer to the example code on the CD or official website)

Step 3: Compile the program

Step 4: Burn the program into RobotLinking Uno board

Step 5: Open the TOOL→Serial Monitor, and we can see the data as below:

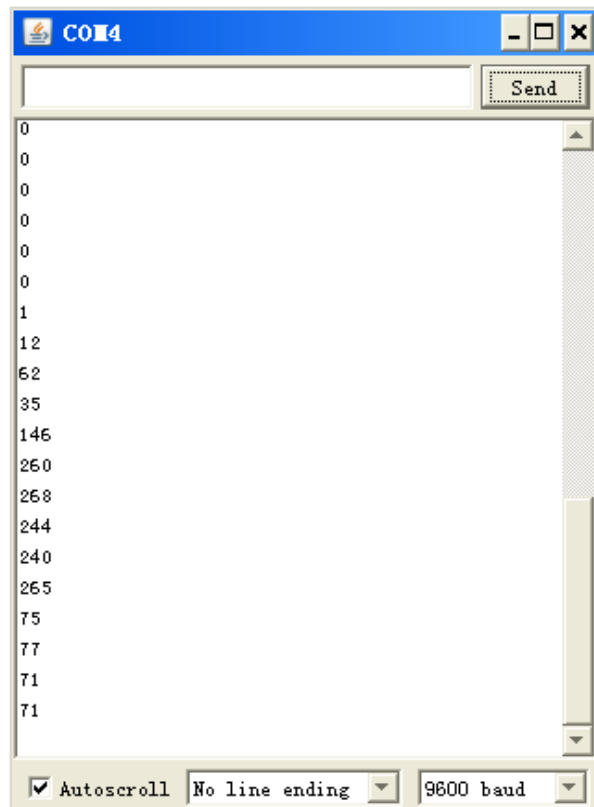

Experimental Summary

Joystick module are a very simple, very practical technology that is surprisingly easy to master. If you feel as though you're struggling, check out our video tutorials on www.RobotLinking.com or ask us questions on our forum.

Lesson 25 LINEAR HALL AND ANALOG HALL MODULE

Introduction

In this experiment, we will learn how to use the linear hall and analog hall module.

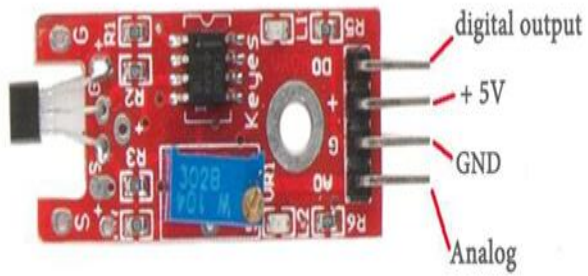

Linear Hall

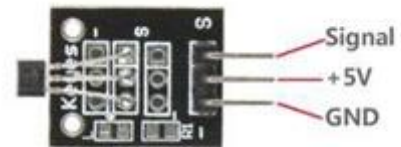

Switch Hall

Components

- 1 * RobotLinking Uno board
- 1 * USB cable
- 1 * linear hall module
- 1 * analog hall module
- DuPont wires(Female to Male)

Principle

Experimental Procedures

Step 1: Connect circuit as shown in the following photo:

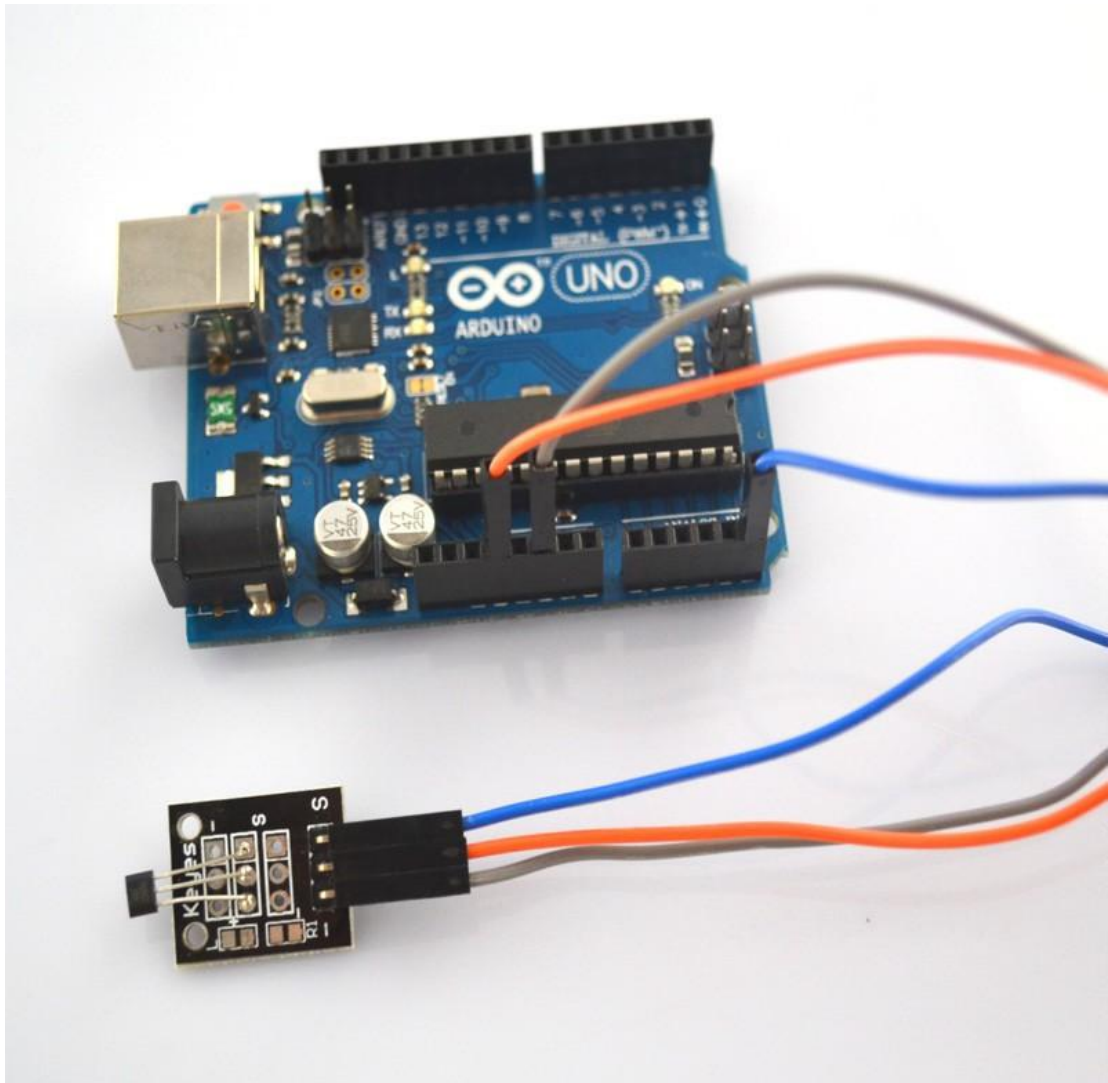

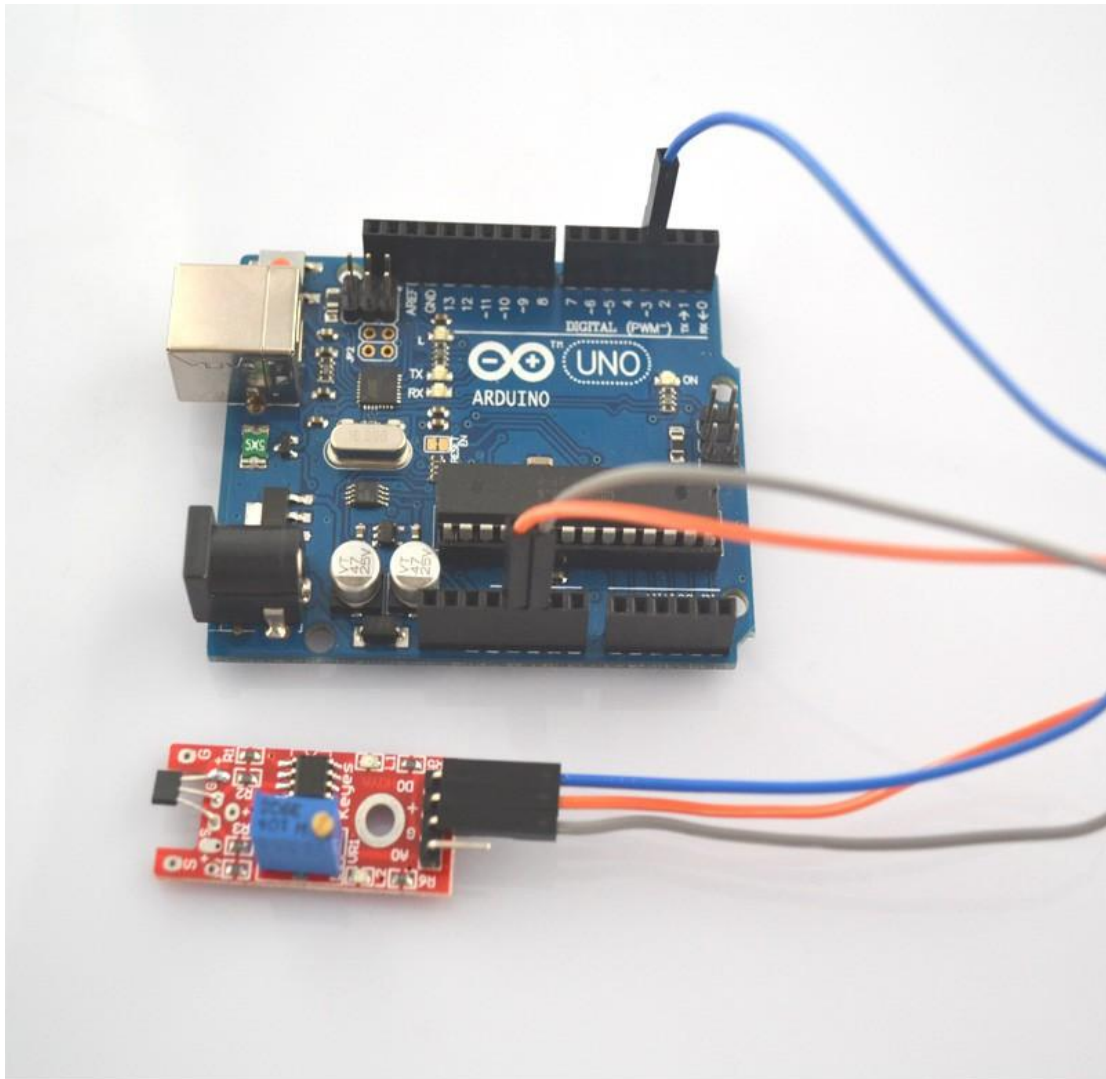

Step 2: Program (please refer to the example code on the CD or official website)

Step 3: Compile the program

Step 4: Burn the program into RobotLinking Uno board

Experimental Summary

Linear hall and analog hall module are a very simple, very practical technology that is surprisingly easy to master. If you feel as though you're struggling, check out our video tutorials on www.RobotLinking.com or ask us questions on our forum.

Lesson 26 TRACKING MODULE AND AVOIDANCE MODULE

Introduction

In this experiment, we will learn how to use the tracking module and avoidance module.

Infrared obstacle avoidance sensor is designed for the design of a wheeled robot obstacle avoidance sensor distance adjustable. This ambient light sensor Adaptable, high precision, having a pair of infrared transmitter and receiver, transmitter tubes emit a certain frequency of infrared, When detecting the direction of an obstacle (reflector), the infrared receiver tube receiver is reflected back, when the indicator is lit, Through the circuit, the signal output interface output digital signal that can be detected by means of potentiometer knob to adjust the distance, the effective distance From 2 ~ 40cm, working voltage of 3.3V-5V, operating voltage range as broad, relatively large fluctuations in the power supply voltage of the situation Stable condition and still work for a variety of microcontrollers, Arduino controller, BS2 controller, attached to the robot that can sense changes in their surroundings.

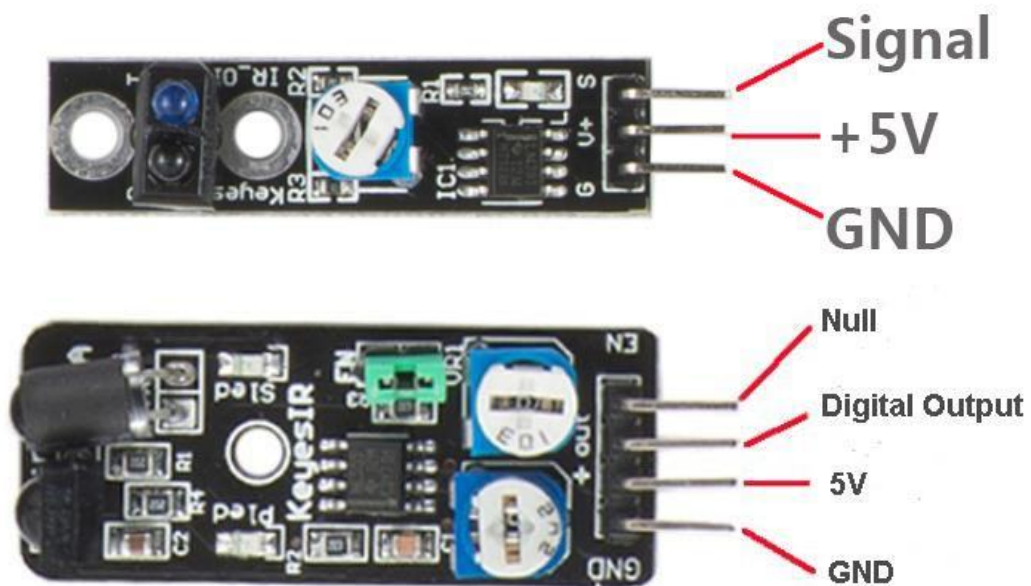

Components

- 1 * RobotLinking Uno board
- 1 * USB cable
- 1 * tracking module

- 1 * avoidance module
- DuPont wires(Female to Male)

Principle

Experimental Procedures

Step 1: Connect circuit as shown in the following photo:

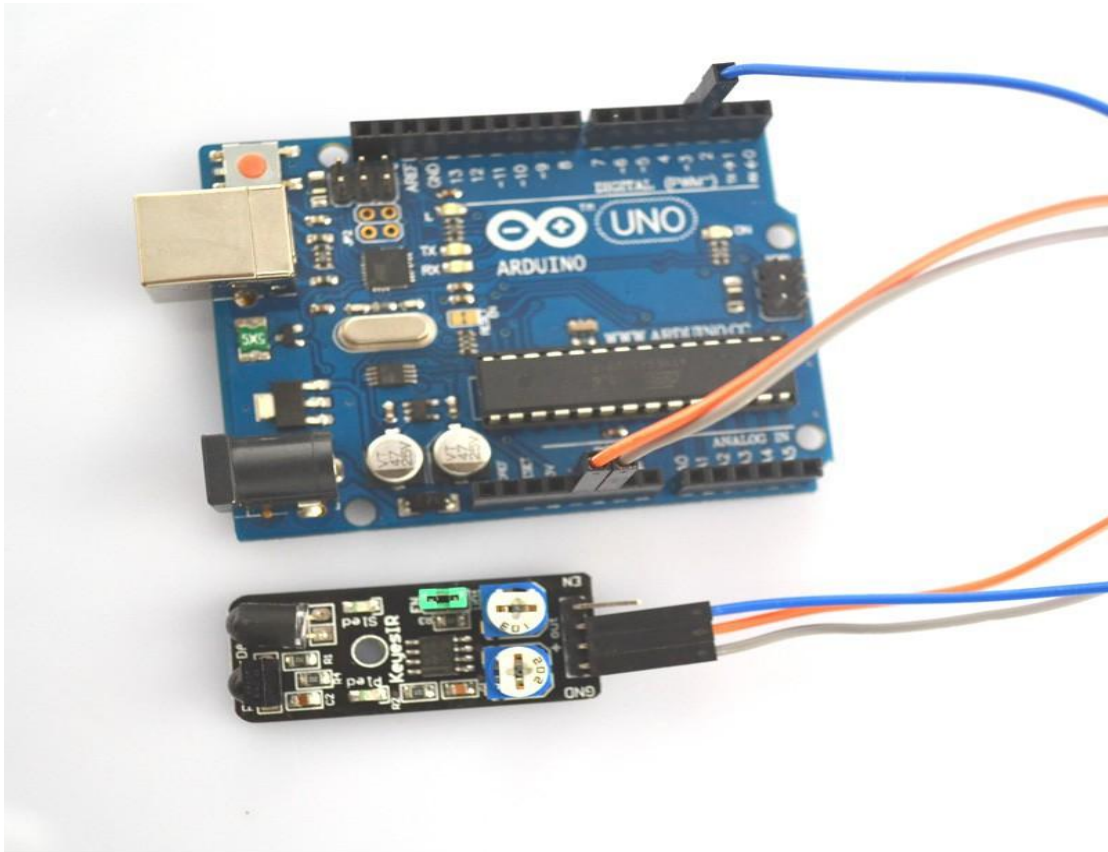

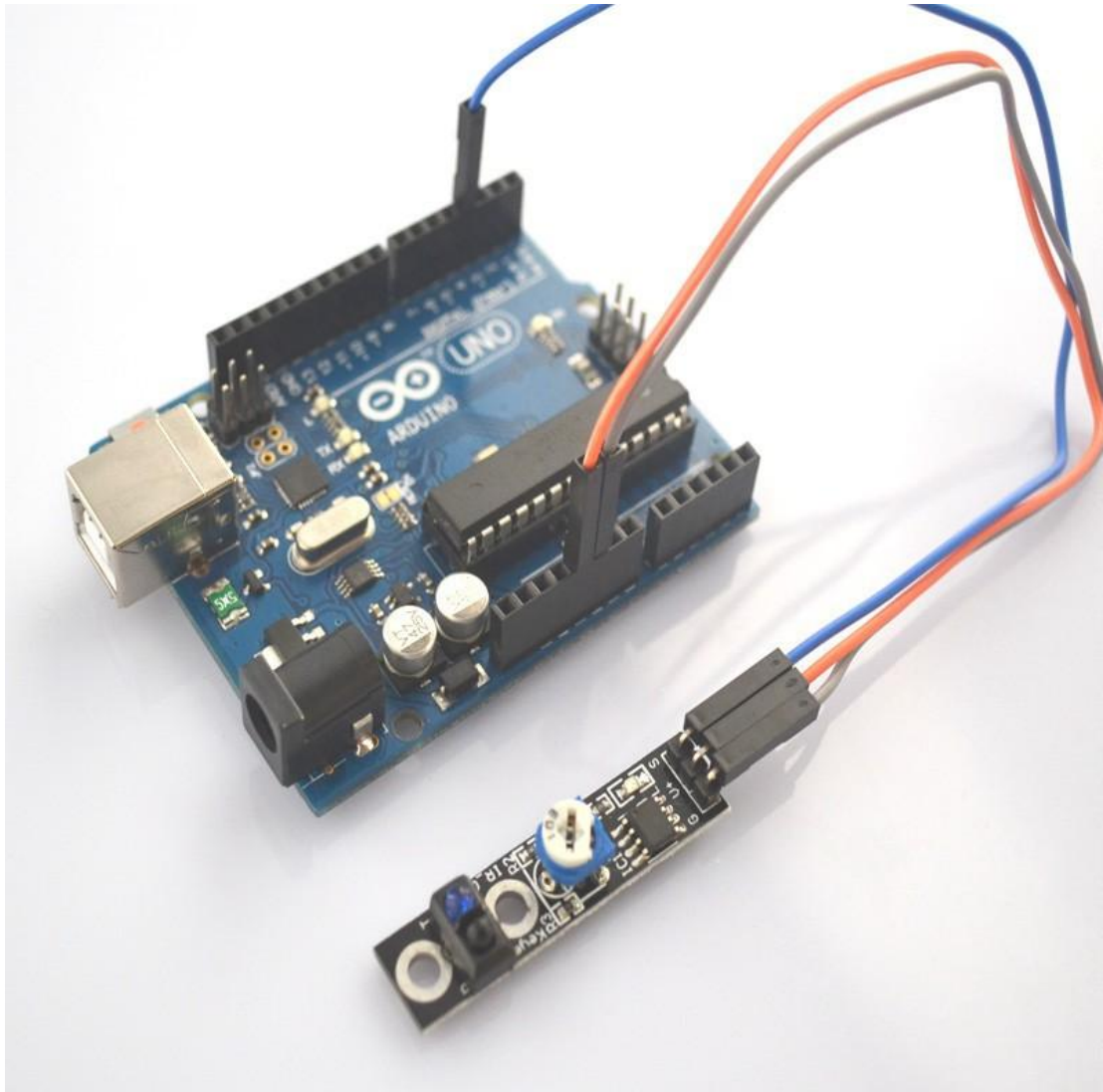

Step 2: Program (please refer to the example code on the CD or official website)

Step 3: Compile the program

Step 4: Burn the program into RobotLinking Uno board

Experimental Summary

Tacking and avoidance module are a very simple, very practical technology that is surprisingly easy to master. If you feel as though you're struggling, check out our video tutorials on www.RobotLinking.com or ask us questions on our forum.

Lesson 27 ROTARY ENCODERS MODULE

Introduction

In this experiment, we will learn how to use the rotary encoders module.

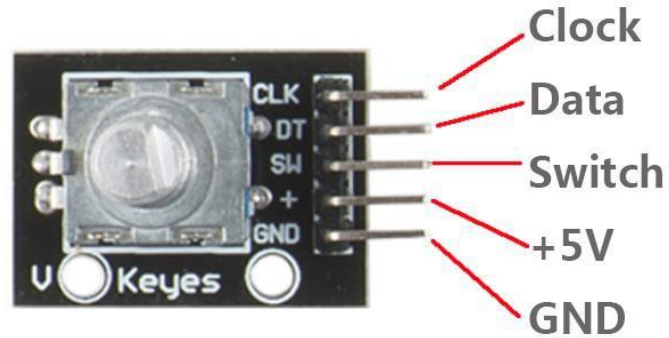

Components

- 1 * RobotLinking Uno board
- 1 * USB cable
- 1 * Rotary encoders module
- DuPont wires(Female to Male)

Principle

Experimental Procedures

Step 1: Connect circuit as shown in the following photo:

GND-GND VCC-5V CLK-2 DT-3 SW-4

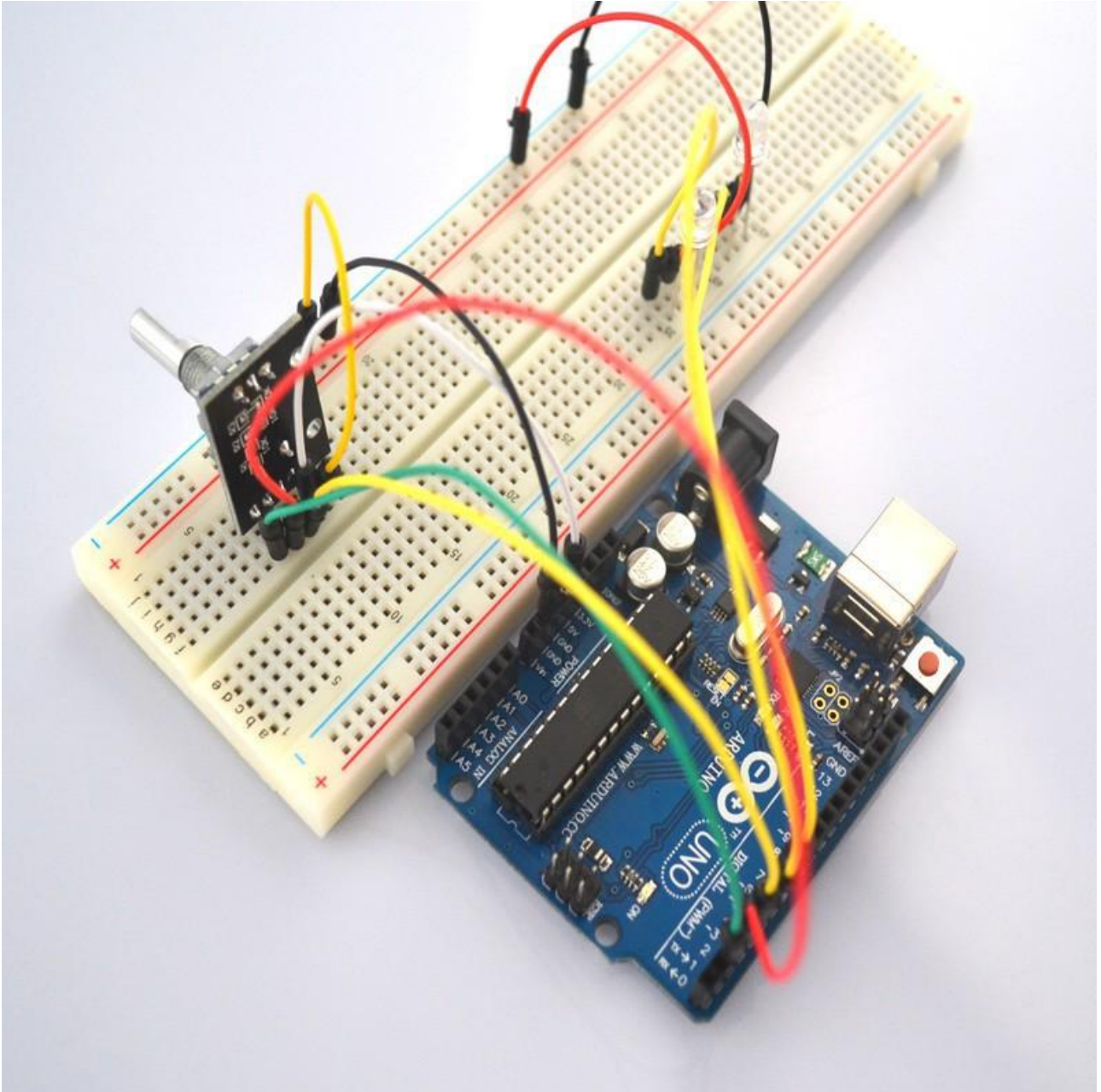

Step 2: Program (please refer to the example code on the CD or official website)

Step 3: Compile the program

Step 4: Burn the program into RobotLinking Uno board

Step 5: Open the TOOL→Serial Monitor, and we can turn the rotary so that the monitor will change the reading number.

Experimental Summary

Rotary encoders module are a very simple, very practical technology that is surprisingly easy to master. If you feel as though you're struggling, check out our video tutorials on www.RobotLinking.com or ask us questions on our forum.

Lesson 28 1 CHANNEL RELAY MODULE

Introduction

In this experiment, we will learn how to use the 1 channel relay module.

Relay is a kind of component when the change of the input variables (incentive) to specified requirements, the output electric circuits of the charged amount occurs due to the step change of a kind of electrical appliances. This company produces the relay module can meet in 28 v to 240 v ac or dc power to control all kinds of other electric parts. MCU can be used to achieve the goal of timing control switch. Can be applied to guard against theft and alarm, toys, construction and other fields. Relay is an electrical control device. It has a control system (also called input circuit) and control system (also called the output circuit), the interaction between. Usually used in automatic control circuit, it is actually with a small current to control large current operation of a kind of "automatic s

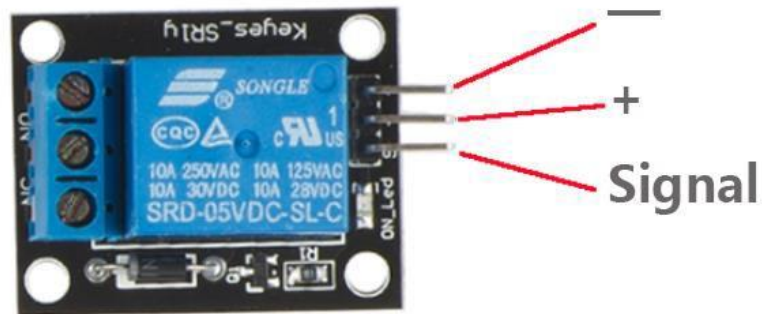

Components

- 1 * RobotLinking Uno board
- 1 * USB cable
- 1 * 1 channel relay module
- DuPont wires(Female to Male)

Principle

Experimental Procedures

Step 1: Connect circuit as :

Uno R3 GND --> Module pin -

Uno R3 +5V --> Module pin +5V

Uno R3 Digital 2 --> Resistor or Not-->Module SW

Step 2: Program (please refer to the example code on the CD or official website)

Step 3: Compile the program

Step 4: Burn the program into RobotLinking Uno board

Experimental Summary

1 channel relay module are a very simple, very practical technology that is surprisingly easy to master. If you feel as though you're struggling, check out our video tutorials on www.RobotLinking.com or ask us questions on our forum.

Lesson 29 HEARTBEAT MODULE

Introduction

This project uses bright infrared (IR) LED and a phototransistor to detect the pulse of the finger, a red LED flashes with each pulse. Pulse monitor works as follows: The LED is the light side of the finger, and phototransistor on the other side of the finger, phototransistor used to obtain the flux emitted, when the blood pressure pulse by the finger when the resistance of the photo transistor will be slightly changed. The project's schematic circuit as shown, We chose a very high resistance resistor R1, because most of the light through the finger is absorbed, it is desirable that the phototransistor is sensitive enough. Resistance can be selected by experiment to get the best results. The most important is to keep the shield stray light into the phototransistor. For home lighting that is particularly important because the lights at home mostly based 50HZ or 60HZ fluctuate, so faint heartbeat will add considerable noise.

When running the program the measured values are printed. To get a real heartbeat from this could be challenging.

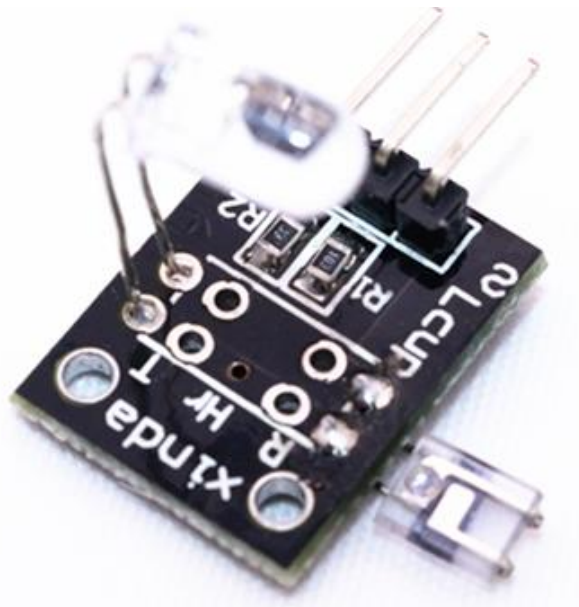

Components

- 1 * RobotLinking Uno board
- 1 * USB cable
- 1 * 1 heartbeat module
- DuPont wires(Female to Male)

Principle

Experimental Procedures

Step 1: Connect circuit as :

Sensor pin S connect to Uno R3 pin Analog 0 / A0

Sensor pin + (middle pin) connect to Uno R3 pin 5+

Sensor pin - connect to Uno R3 pin GND

Step 2: Program (please refer to the example code on the CD or official website)

Step 3: Compile the program

Step 4: Burn the program into RobotLinking Uno board

Experimental Summary

Heartbeat module are a very simple, very practical technology that is surprisingly easy to master. If you feel as though you're struggling, check out our video tutorials on www.RobotLinking.com or ask us questions on our forum.